

Machine Sewing

 *Soft Fabrication Skills*

A Brief History

- Stitching awl: Central Asia, 45000 BCE
- Forms a lockstitch: an upper and lower thread are entwined to form a stitch
- Still used in shoemaking, leatherwork and sewing thick materials (canvas, denim)

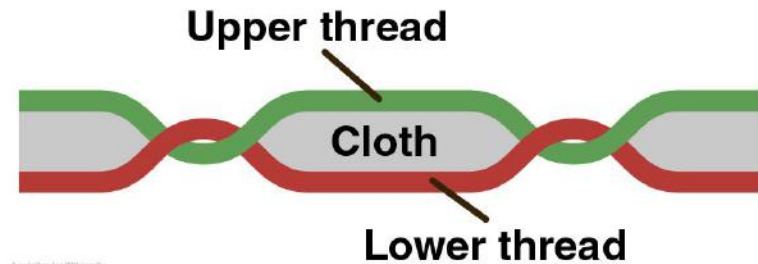



A Brief History

- Late 18th century during industrial revolution: mechanical device to aid sewing
 - designed by Thomas Saint, built by Charles Wiesenthal
- By mid 1800's sewing machines were rotary or treadle powered
- First electric home machine introduced by Singer in 1921



hand-cranked sewing machine,
Nothmann Brothers (German), 1900

How It Works

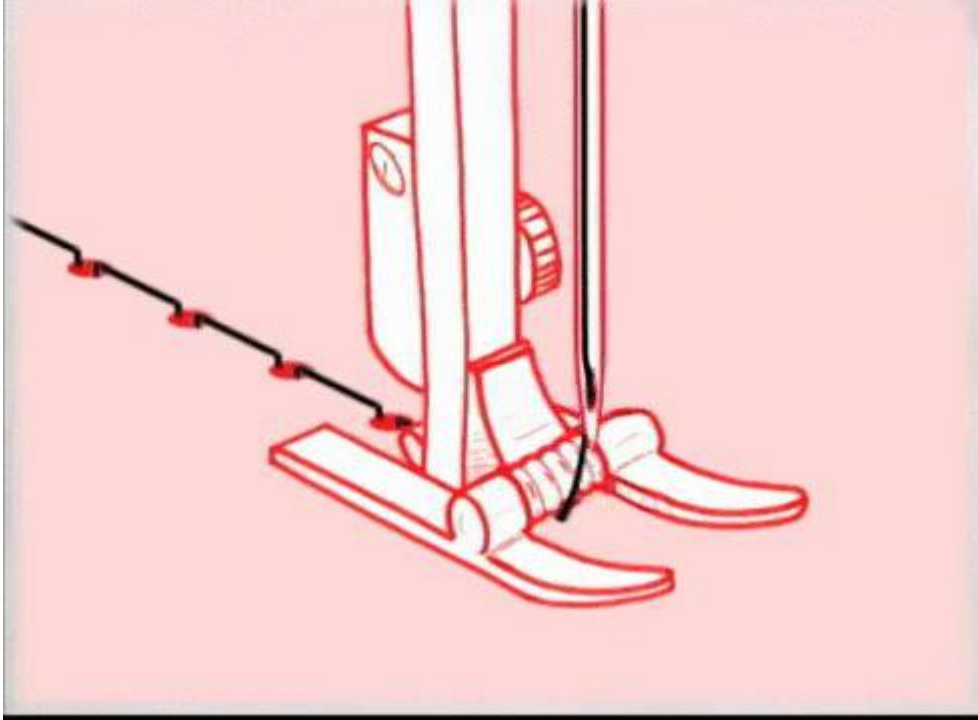

- Needle and bobbin thread come together to form a lockstitch
- Allows the stitch to be made anywhere on the fabric

Home Sewing Machines



mid 1950's - 60's



1970's - 1980's



1990's?

Home Sewing Patterns

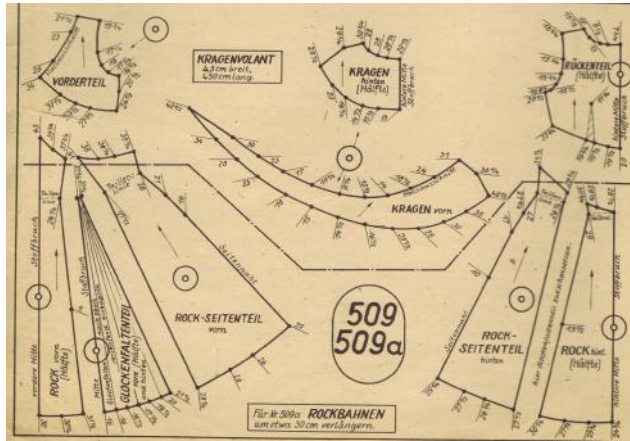

1860's: mass produced clothing patterns in a variety of sizes, made European styles available to US



Butterick, McCall's, Simplicity, Vogue

Flour sack dresses



1920's - 1950's, USA

Other Sewing Machines



Embroidery machine



Serger

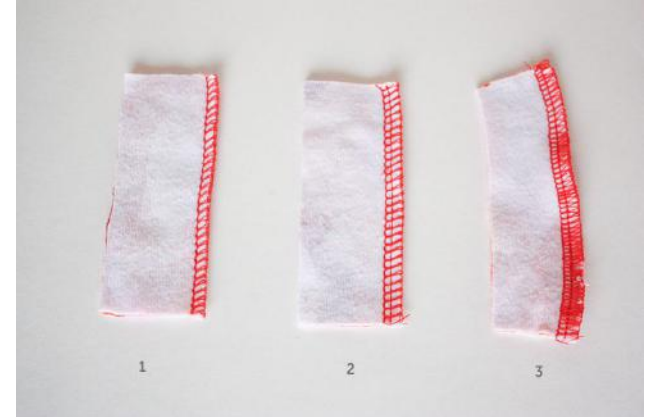

More Machines!



Long-armed quilting machine



Chain stitch sewing machine





Clothes and other hand sewn items become more affordable

vs.

Exploitative labor + environmental practices



Triangle Shirtwaist Factory fire,
NYC, March 25, 1911



Rana Plaza collapse,
Dhaka, Bangladesh, April 24, 2013

Sewing a Space Suit

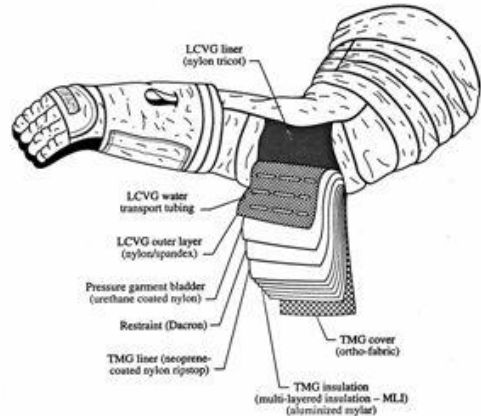

Cross section of material layup used for fabric for the arms and legs of the spacesuit.



Dava Newman, Biosuit

- Apollo spacesuit (1960's)
- Seamstresses from Playtex corporation
- Sewing process vs. engineering process
- Mobile Pressure suit? (1947 + 2007)
- [cool reading!](#)

Hazmat / Protective Suits



Jill Andrews,
costume & wedding
dress designer
(elastics, rolls up
in one piece)

Allie Sibole, JHU
Bioengineering grad
student (zips off in
one piece)



Johns Hopkins University hosted a weekend-challenge to redesign suits for Ebola/infectious disease caregivers in 2014



Threadstading - Disney Research



Do Ho Suh - Staircase

Sewing with Conductive Material

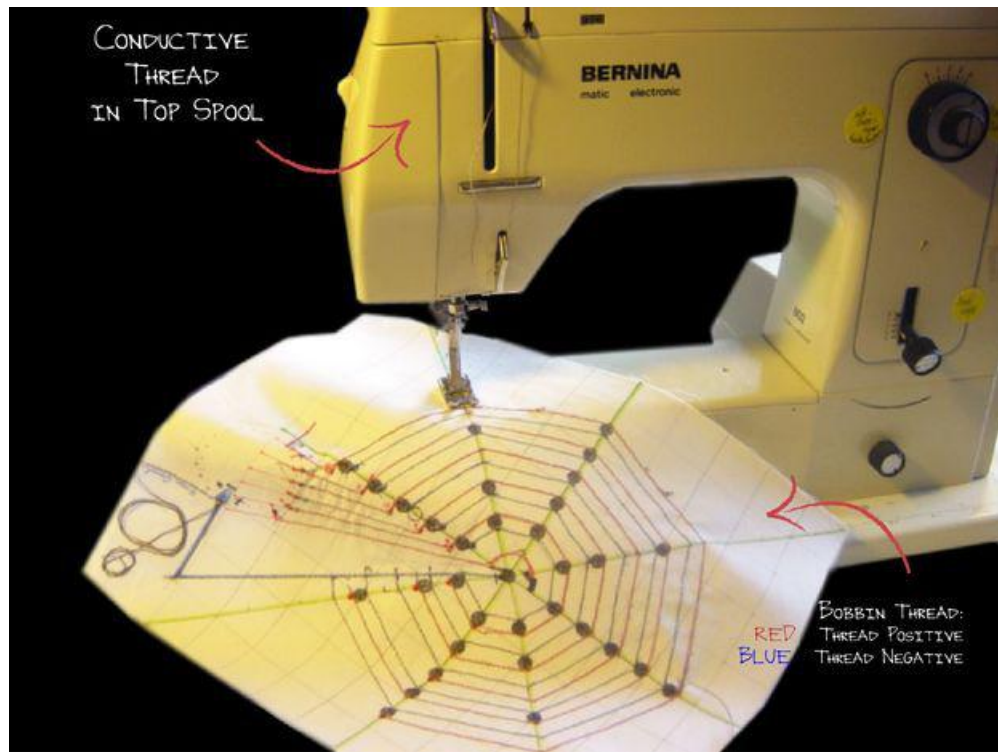
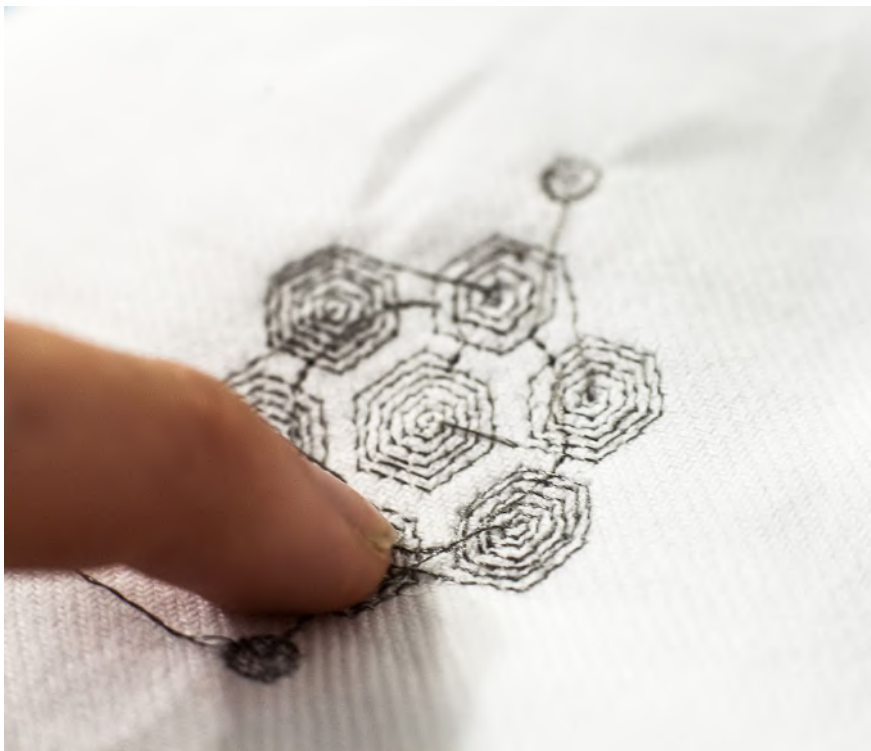

Materials + Tools



- machine with pedal
- fabric scissors
- pins
- thread on spool
- fabric/material!

Safety and Precautions!

- Make sure long hair is pulled back and baggy/loose clothing is secured
- Keep foot off of pedal or turn machine off when making adjustments
- Be cautious when sewing thick fabrics - too much stress on the needle can cause it to break

Machine Anatomy

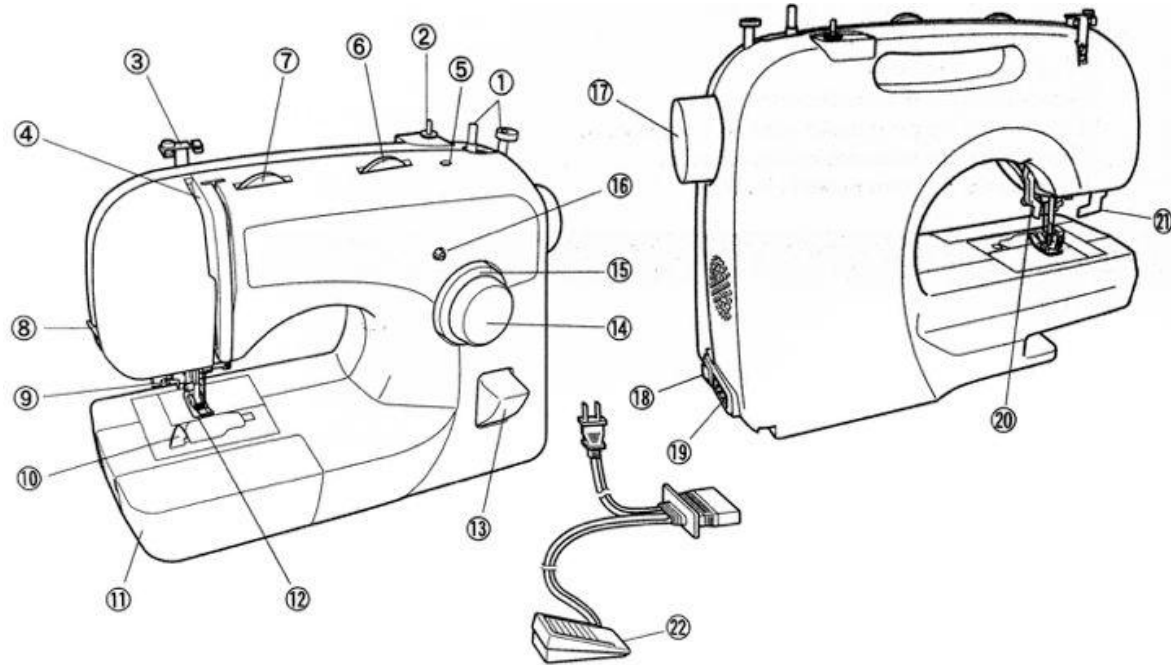

Lowering/Raising Presser Foot

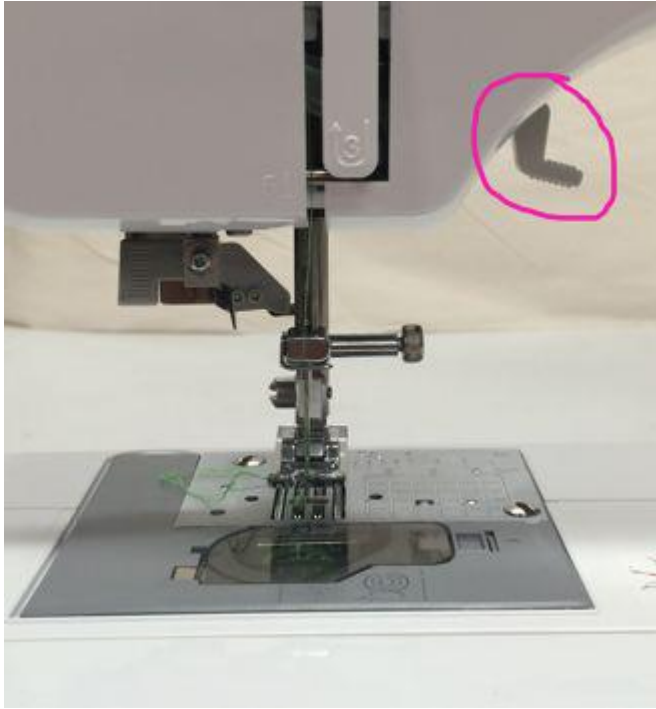

Lever is up, presser foot is up

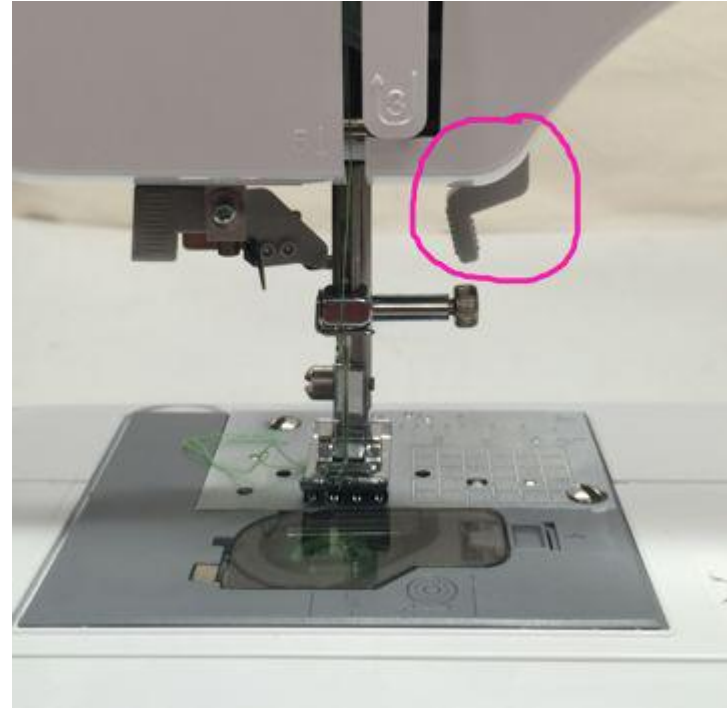

Lever is down, presser foot is down

Handwheel



Winding the bobbin



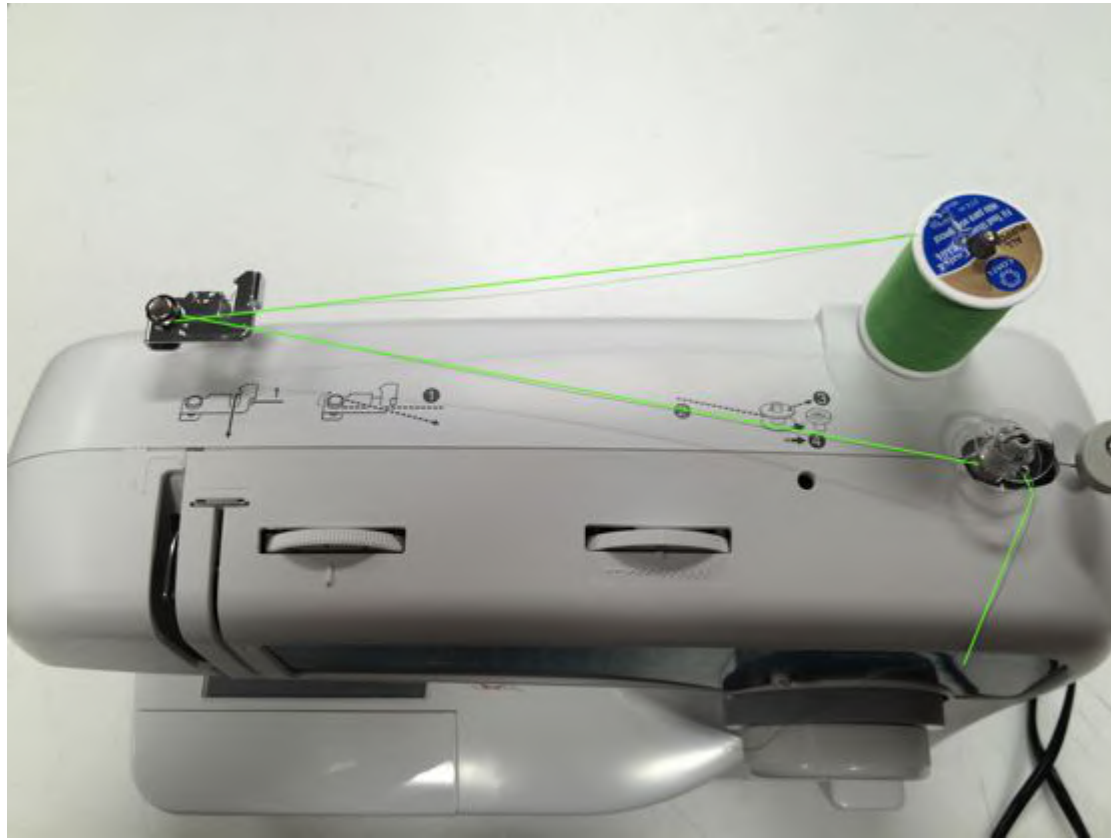

Feed the thread across the machine using the guides established by the circled numbers

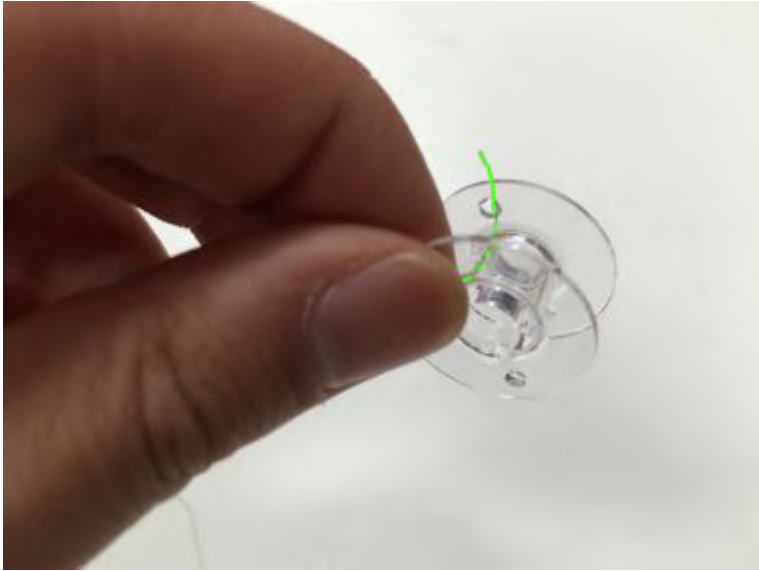

Feed tail of thread through the hole on the top of the bobbin



Place bobbin on the grey rod below the spool

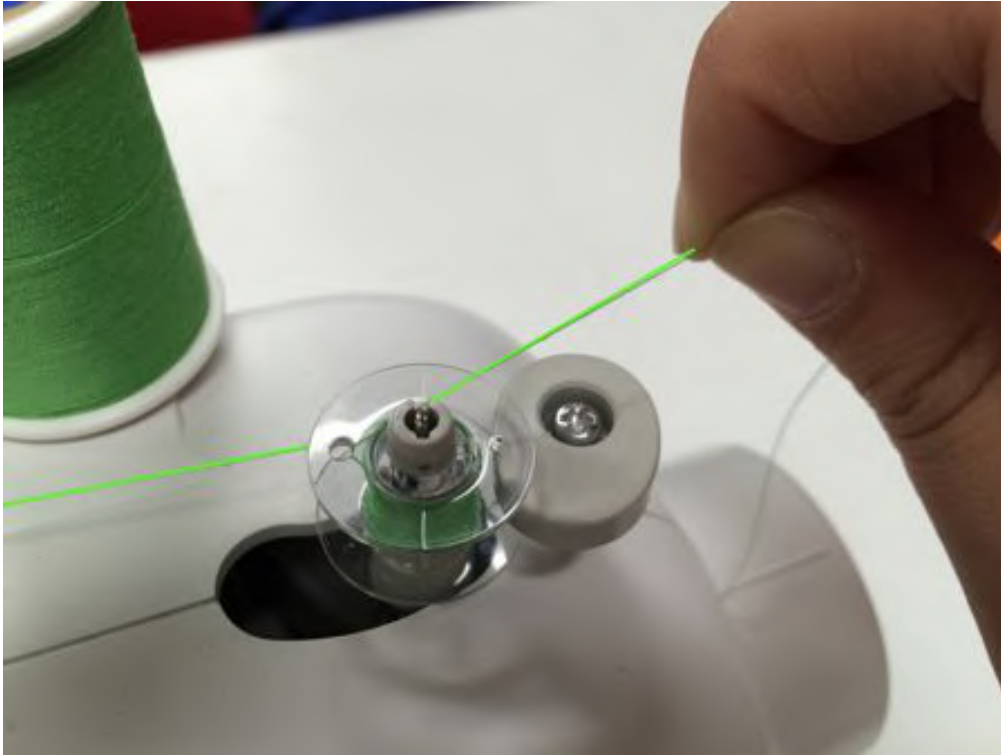

Push the bobbin over to the plastic stopper piece.

Hold the tail of the thread as you press down on the sewing machine pedal to fill the bobbin.

Make sure the tail does not get loaded into the bobbin!

When the bobbin is full, the bobbin will automatically stop.

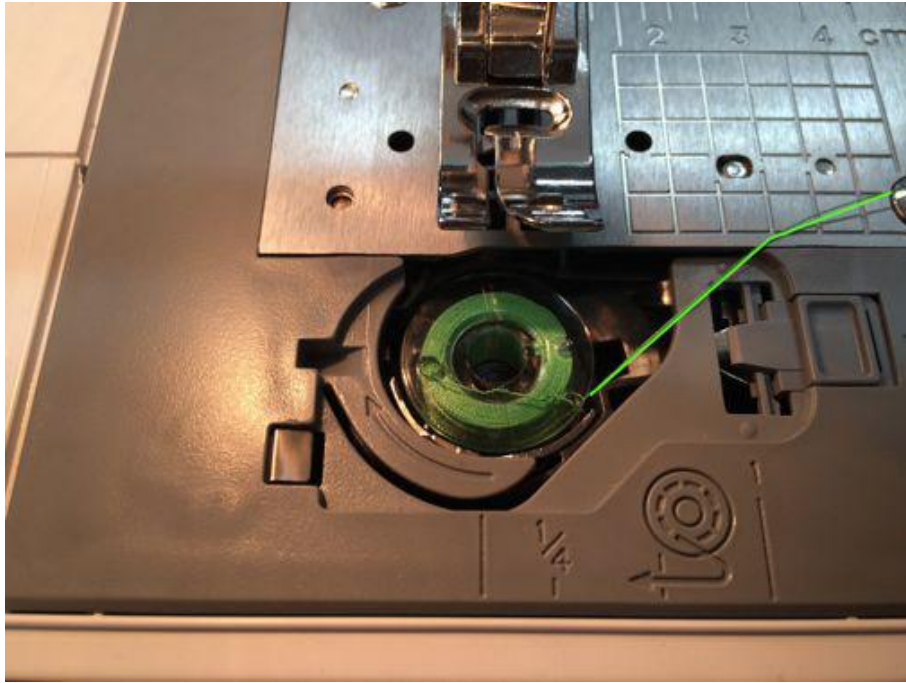

Insert the bobbin so that the bobbin rotates counterclockwise when you pull the thread

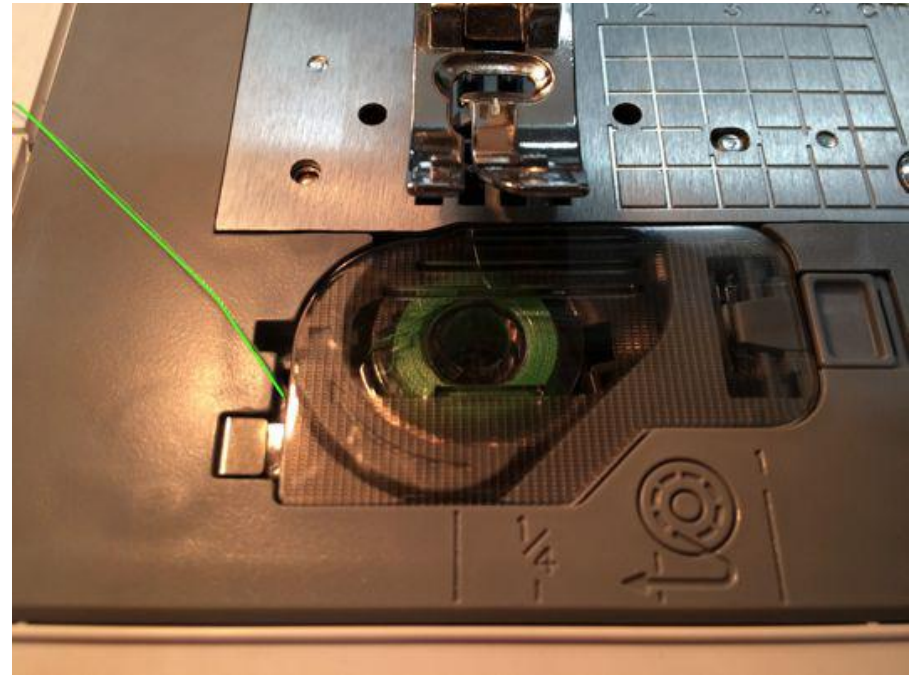

Bring thread under plastic arrow piece, leave ~3" tail, replace bobbin cover

Threading the Machine



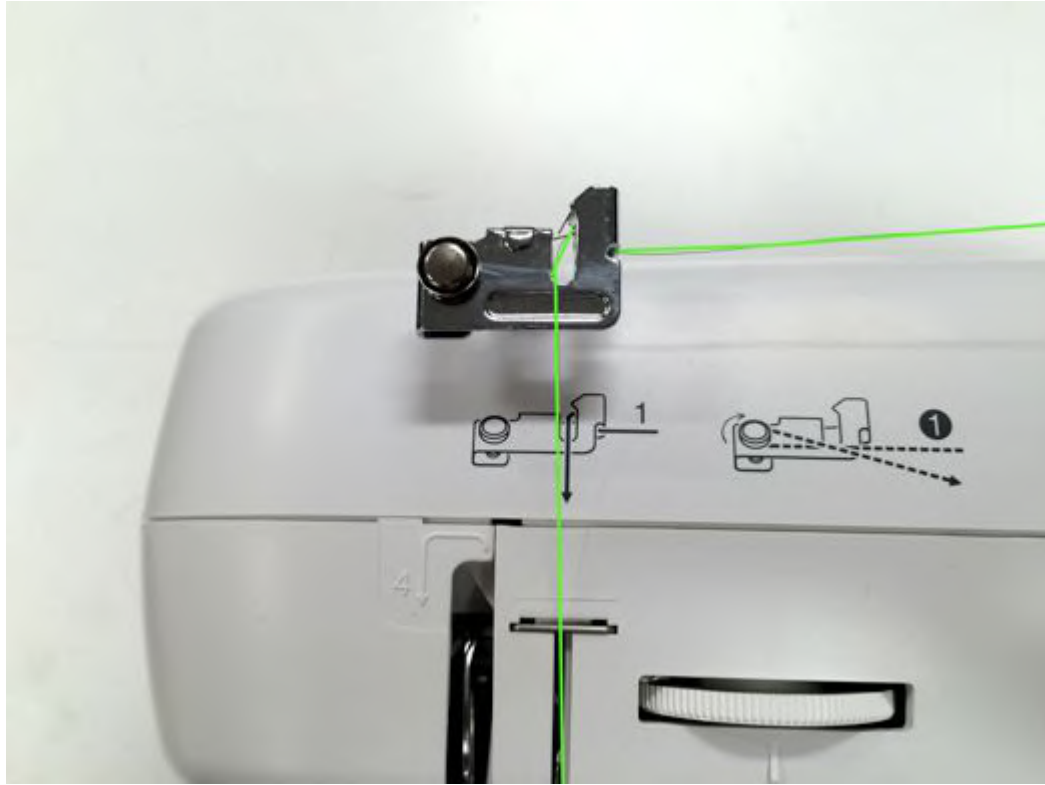

This time we are following the non-circled numbers.
1. Pull the thread under the metal piece.

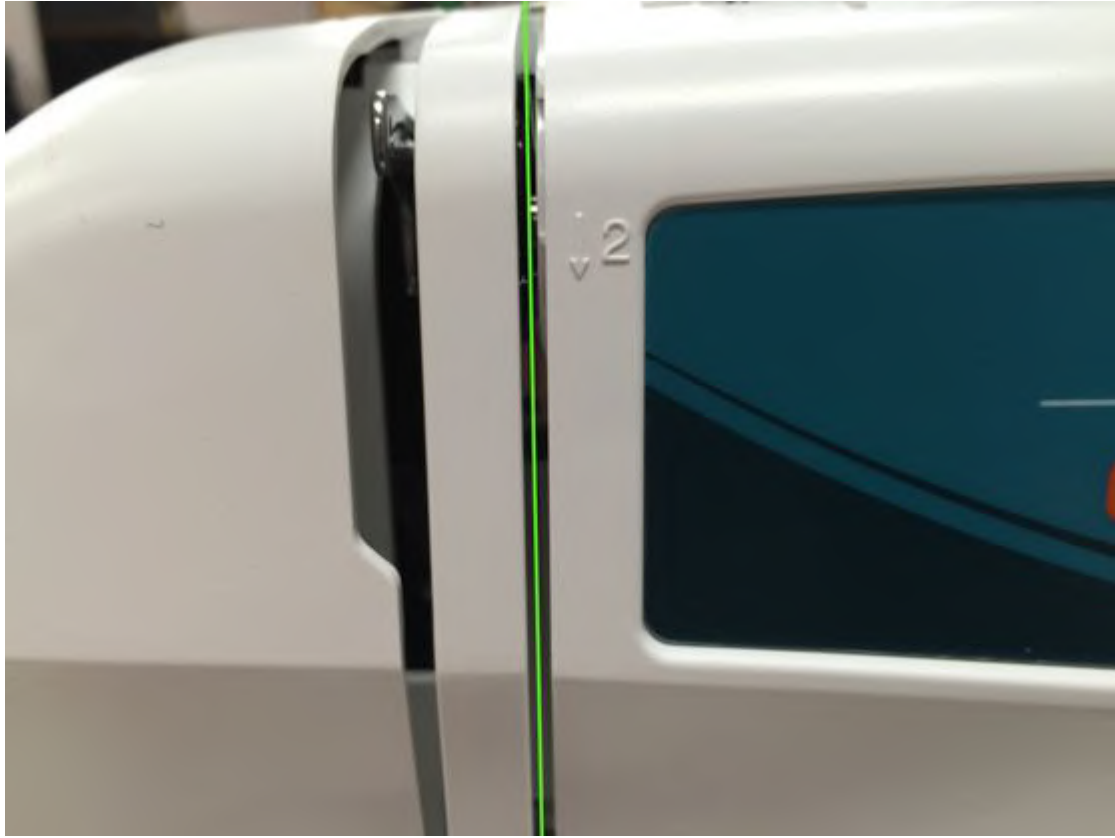

2. Bring the thread down the crevice

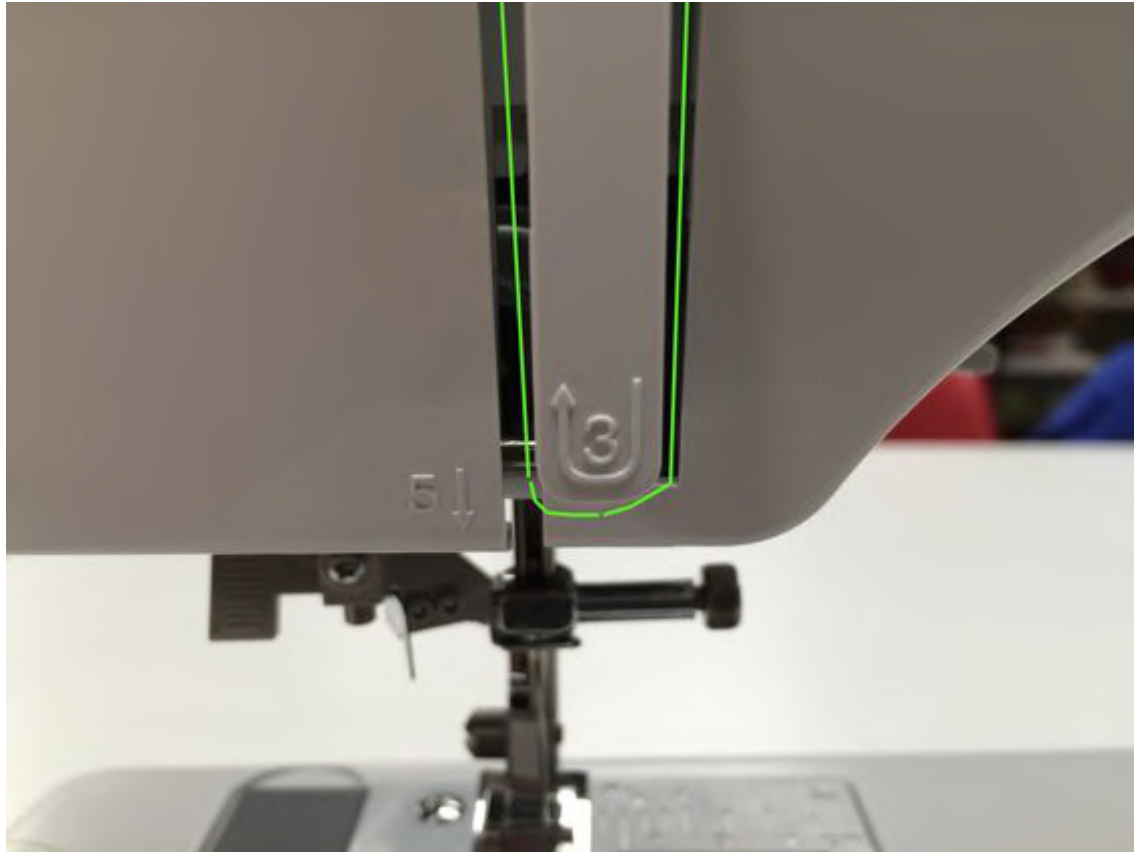

3. Make a U turn with the thread around the corner

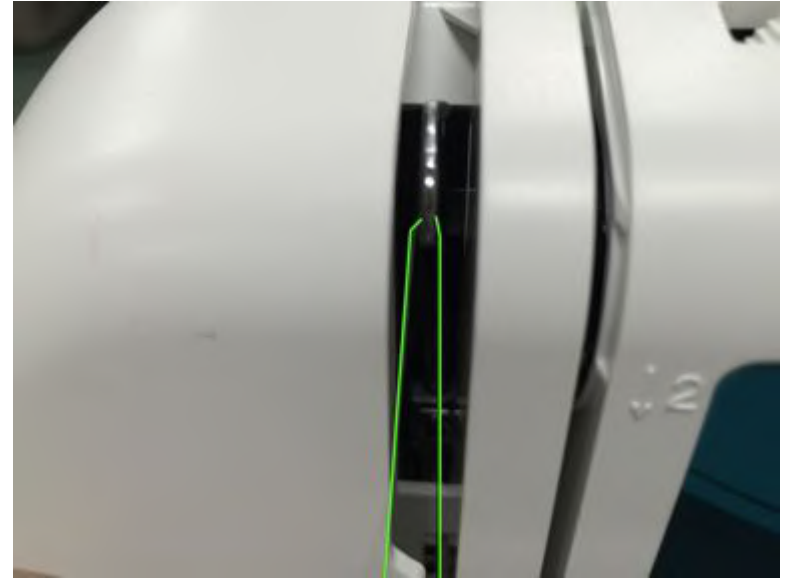
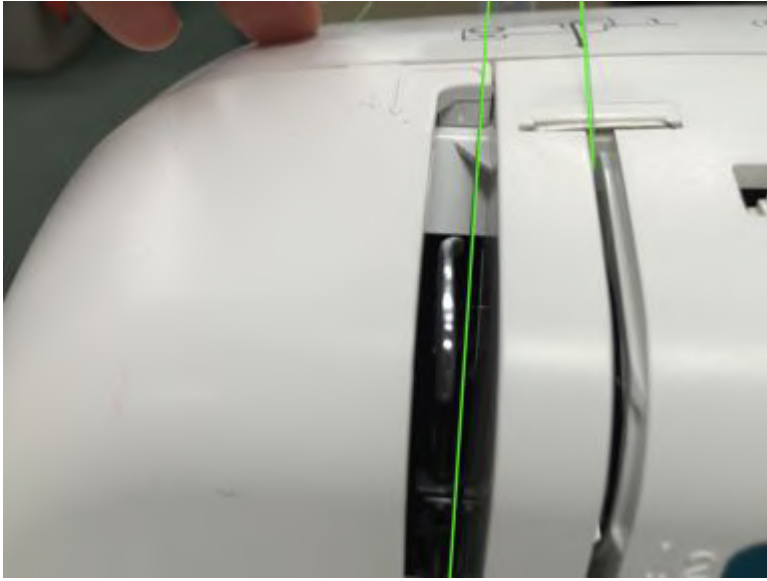

4. The thread is pulled up on the right side of the metal arm, then pulled around and down onto the left side so it is sitting in the hook

****tip**** use the handwheel to move the metal arm so it's easier to thread!

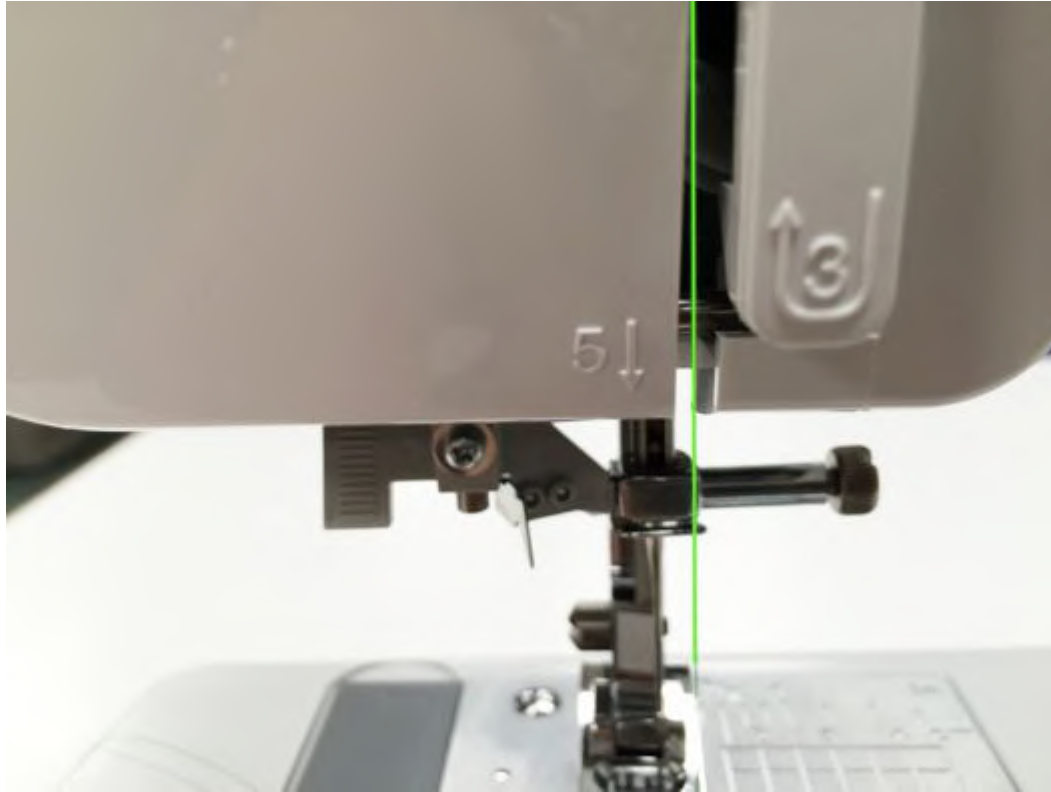

5. The thread is now hanging down by the needle area

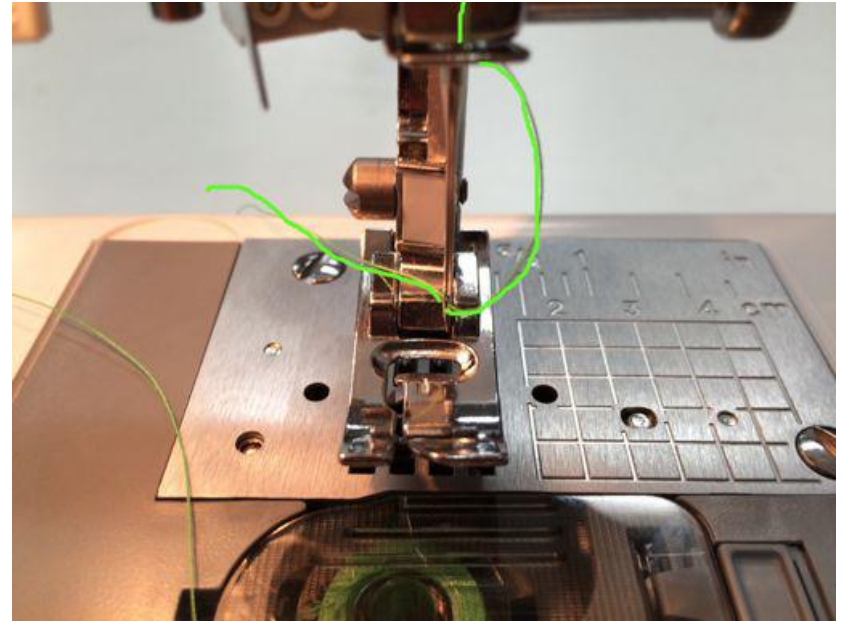
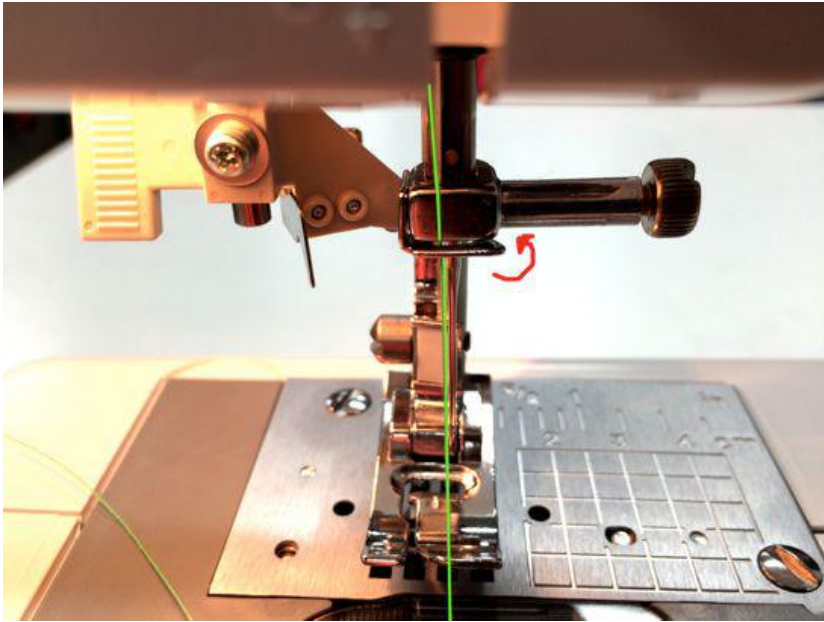

6. Pull the thread down by the needle. Bring it around the right side of the metal so that it can sit behind the bar.

Thread the needle. Pull a ~4" long tail through the needle.
(the eye of the needle for a sewing machine is down by the point!)

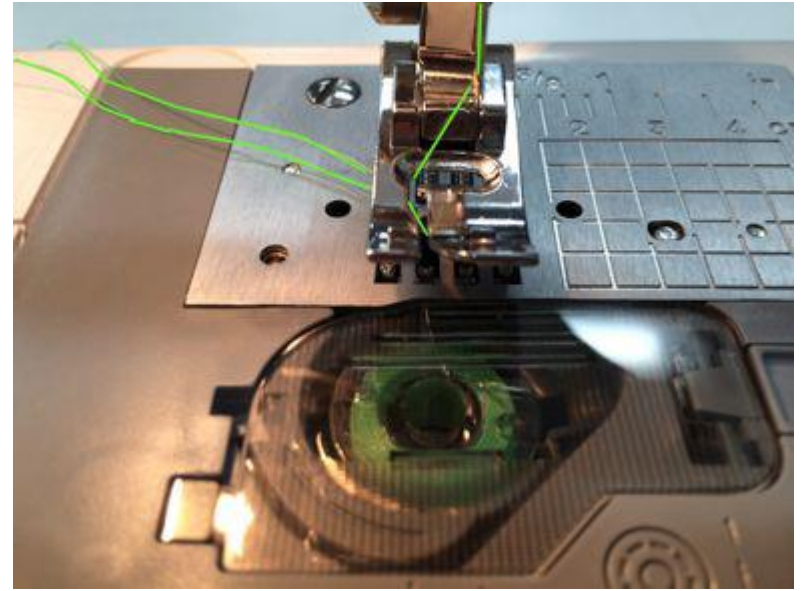
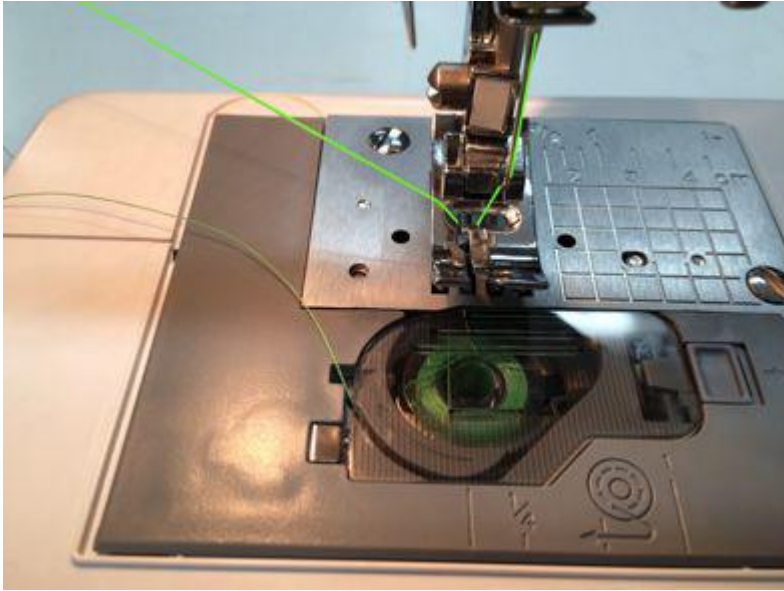

Turn the handwheel on the right side of the machine.

The spool thread should catch onto the bobbin thread and pull it out through the bottom feed.

Straight Stitch Setting



The inner selection dial is set to 2, the outside stitch length dial is set to 4.

The stitch width dial on the top of the machine is set to 0.

DEMO time!

Sewing Machine Samples

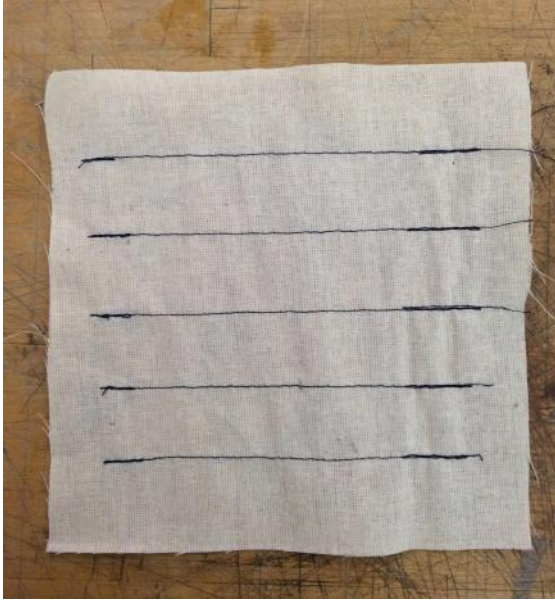

5 rows of straight
stitches



Turning corners:
concentric squares



Making curves:
Concentric circles

Sewing Machine Samples



Stitch sampler

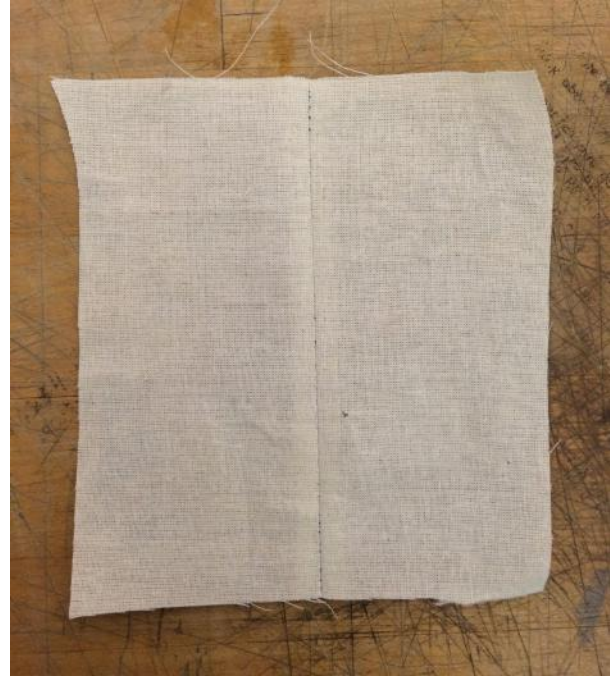

Sewing two pieces
together

Using Pins

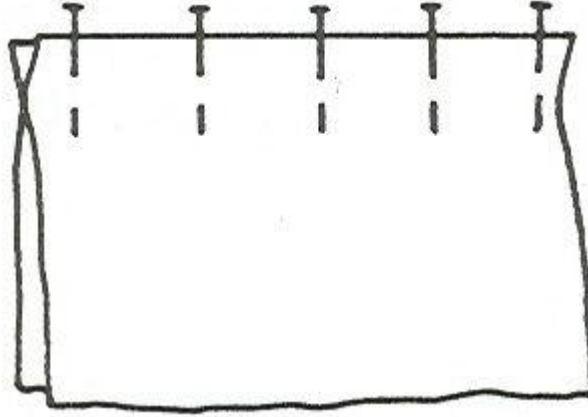

Pins are usually placed perpendicular to the line that is being sewn.

Remove the pin before your needle comes to it!