

# 99-353 SolidWorks and Laser Cutting

## Kerf and Joinery

Dave Touretzky  
Computer Science  
Carnegie Mellon University

# Beam Width

- The beam cuts by burning and melting.
- The width of the beam is non-negligible.

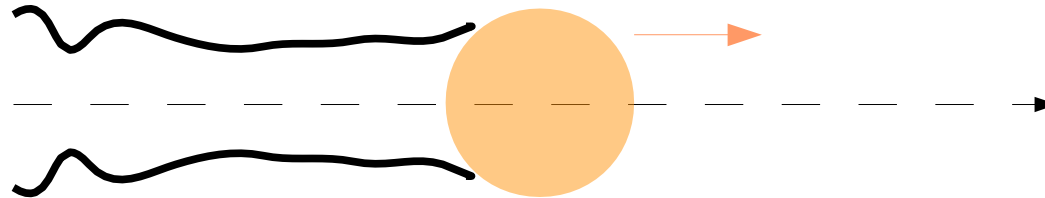

# Kerf

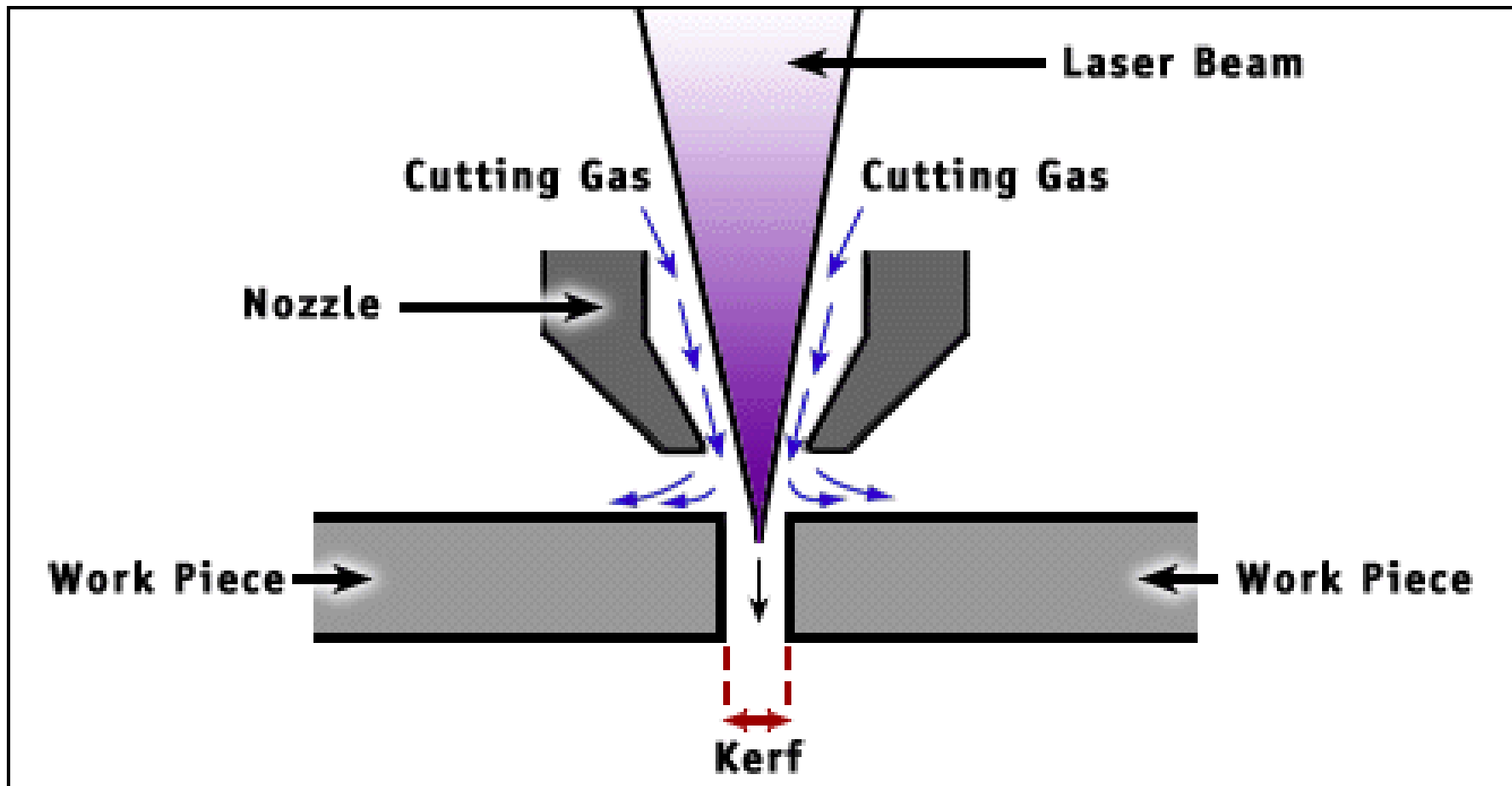

# Kerf

- Typically 0.08 to 0.45 mm (3 to 18 thousandths of an inch), depending on:
  - Laser optics and focusing
  - Type of material
  - Thickness of material
- Consequences:
  - Parts will be undersize
  - Holes will be oversize
- Example: 0.1 inch diameter holes in acrylic:
  - Measured diameter 0.106 inches (kerf 0.006")

What does this mean when you are sizing the outer dimensions of a part? Sizing a hole?

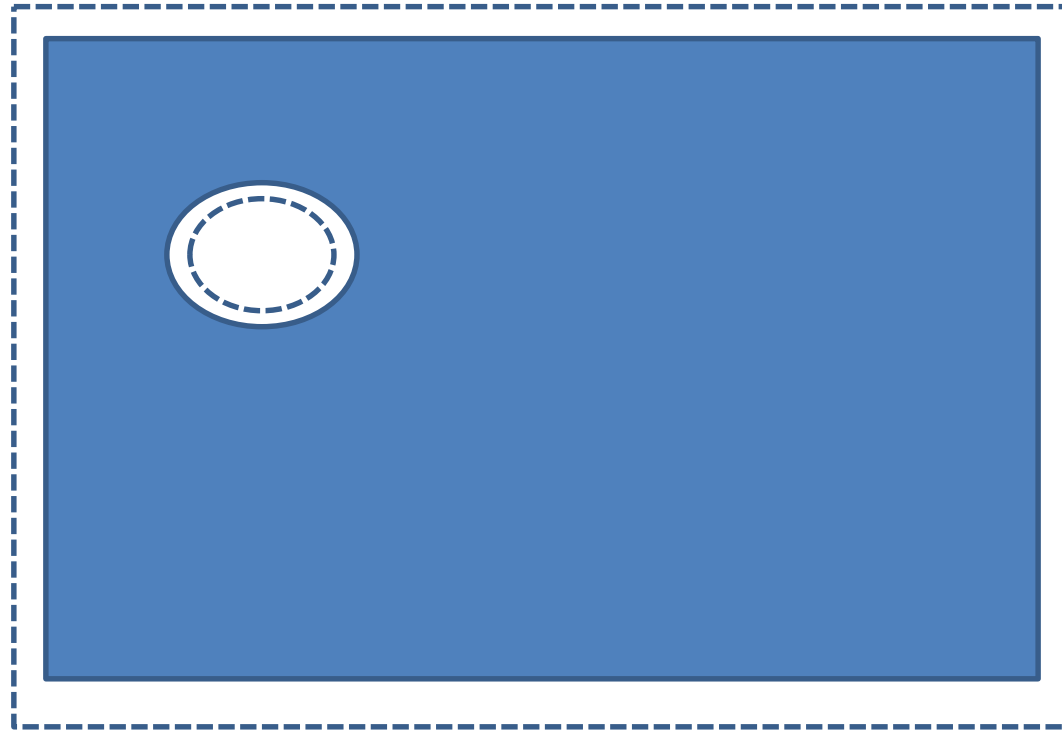

# Offset Kerf

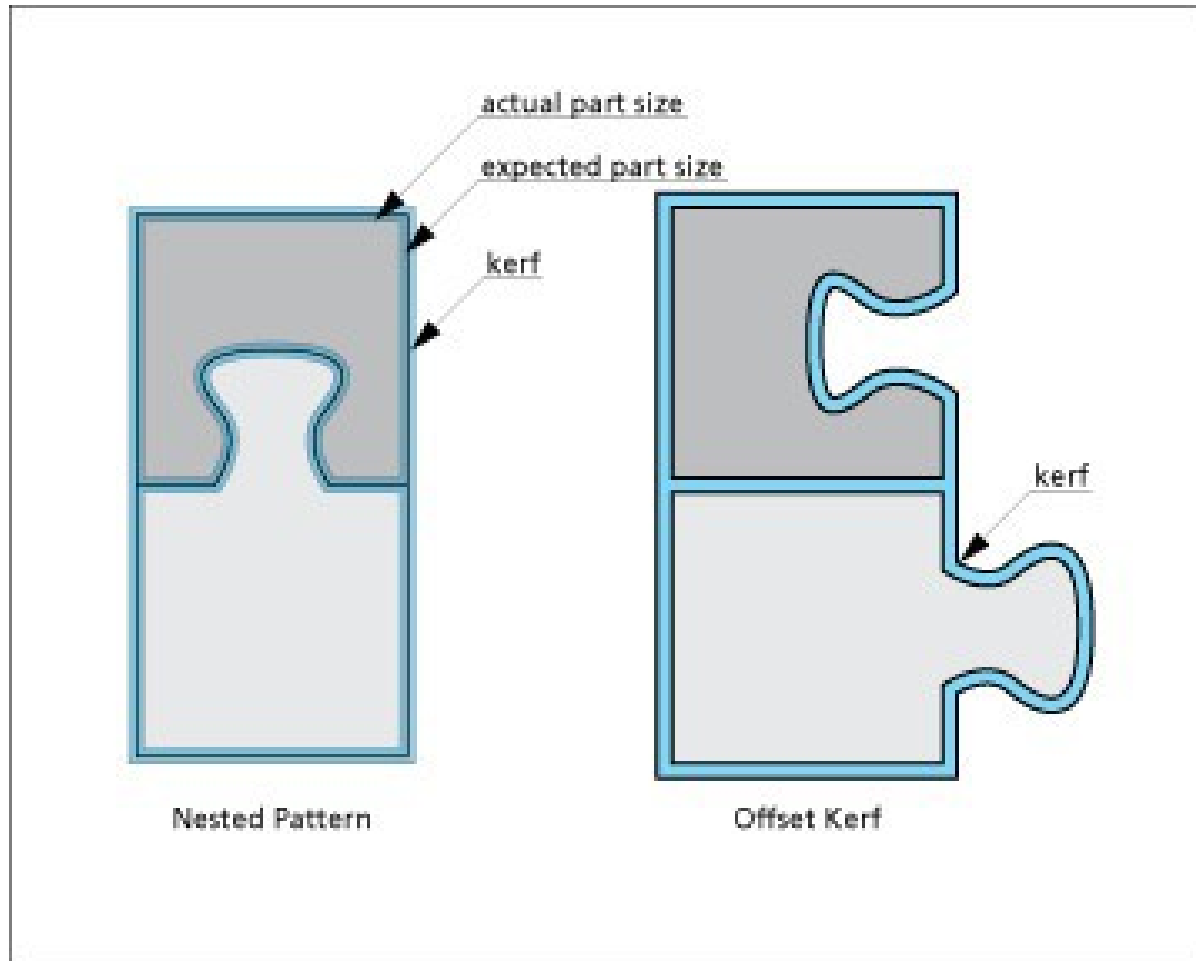

Can do this in SolidWorks with Insert > Faces > Move.

# Kerf and Puzzle Pieces

No correction:

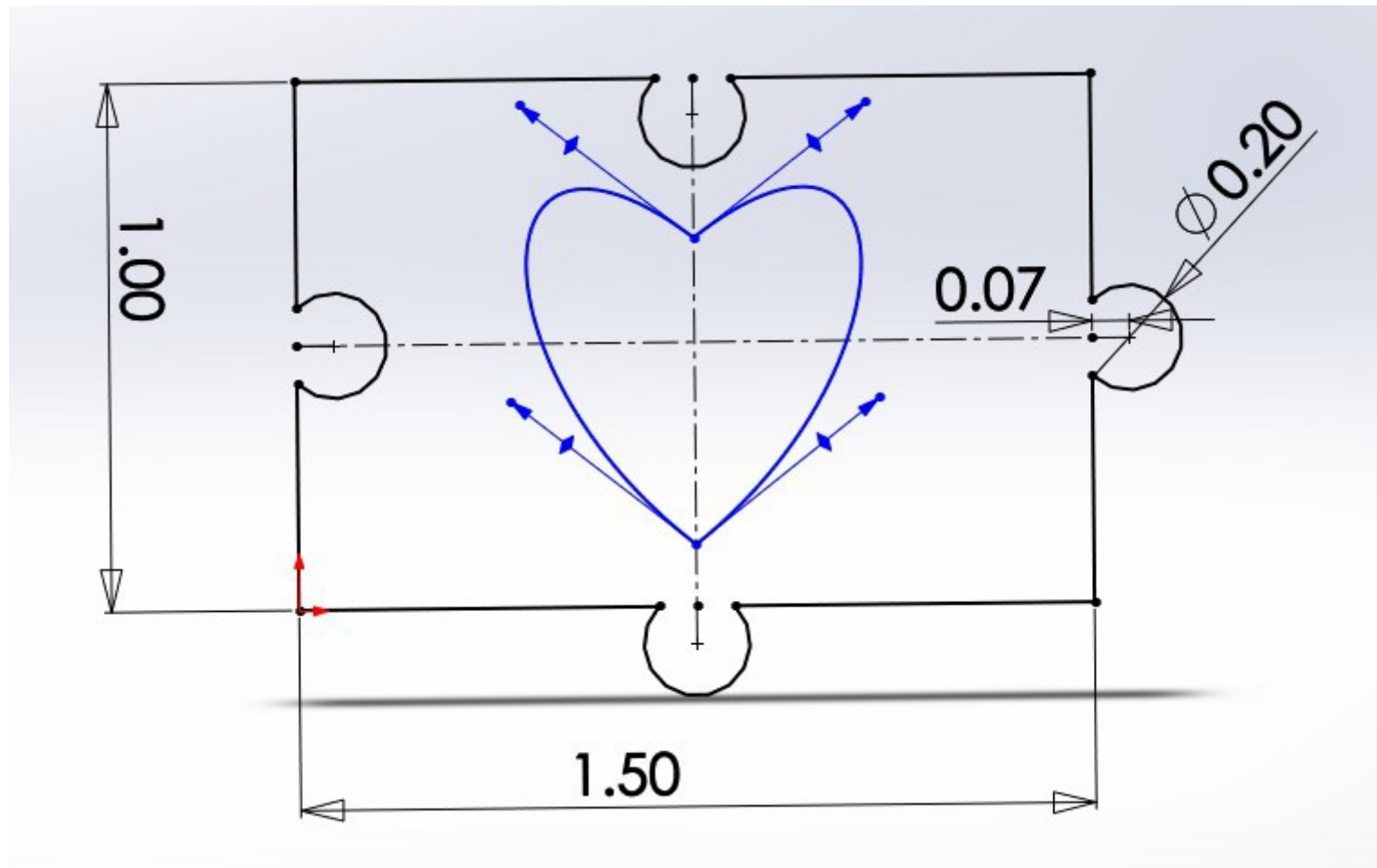

# Faces > Insert > Move : Offset

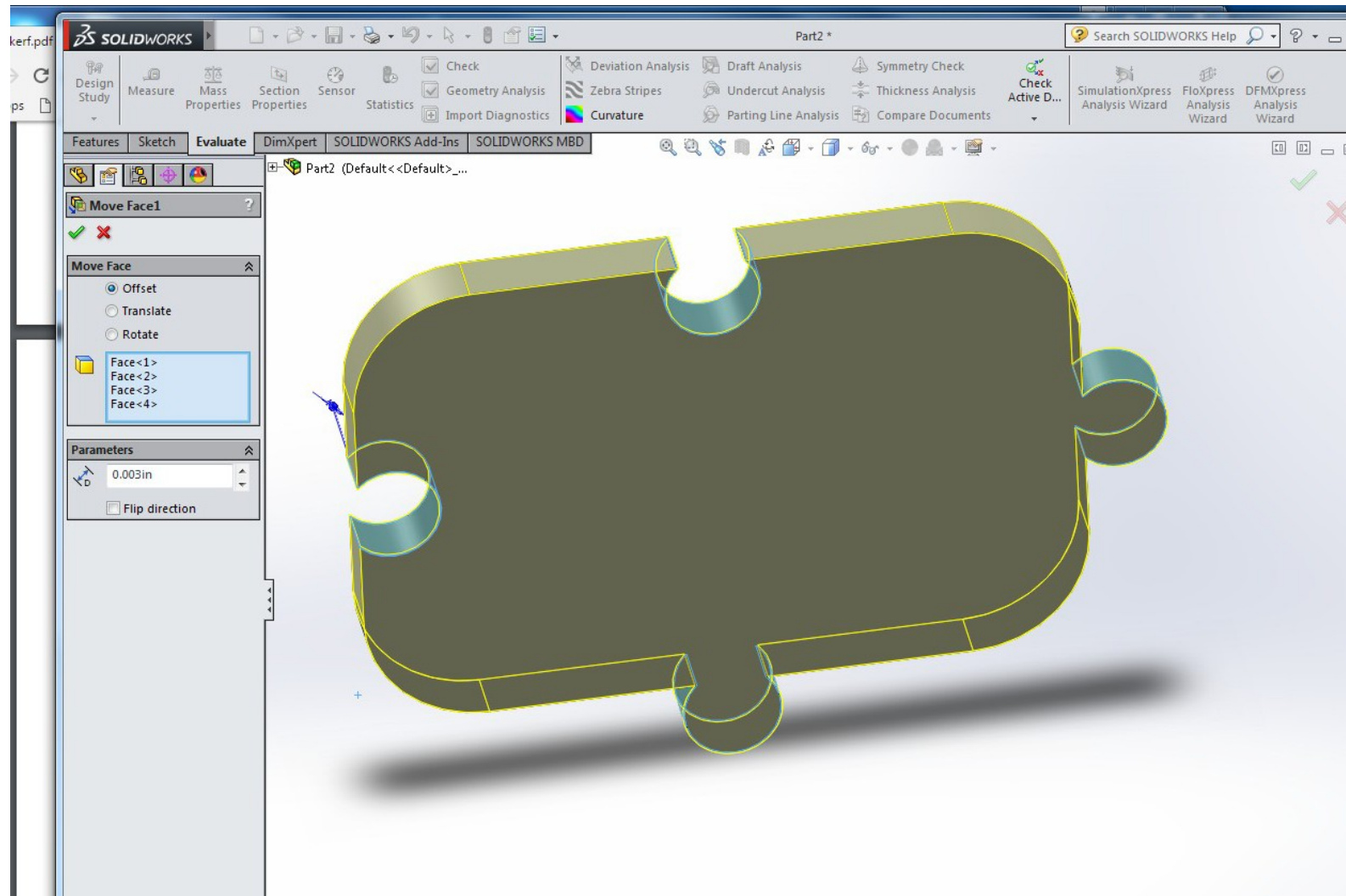



# Interference Shows the Offset

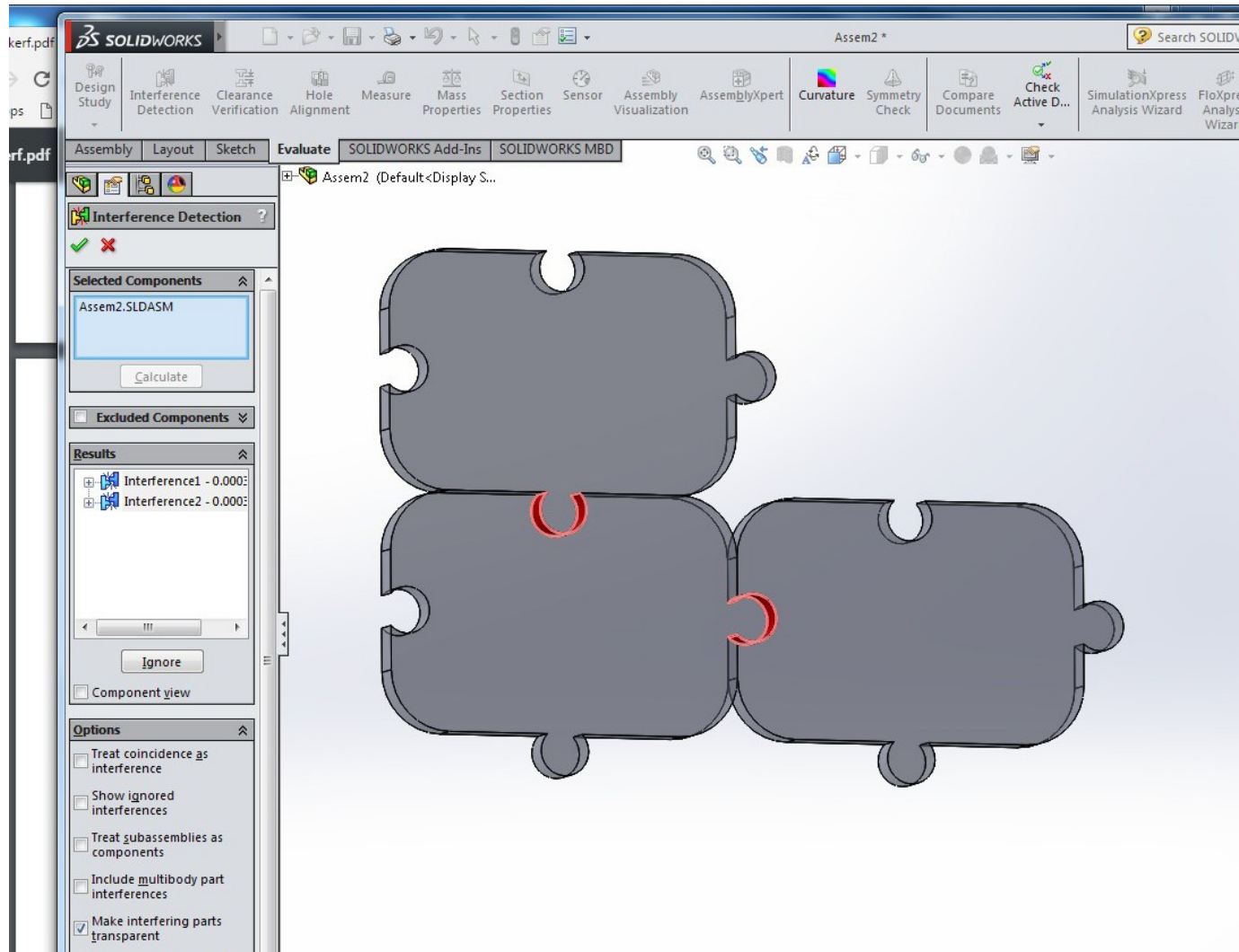

# Making a Box

- Tab and slot construction
- Fasteners through the tabs

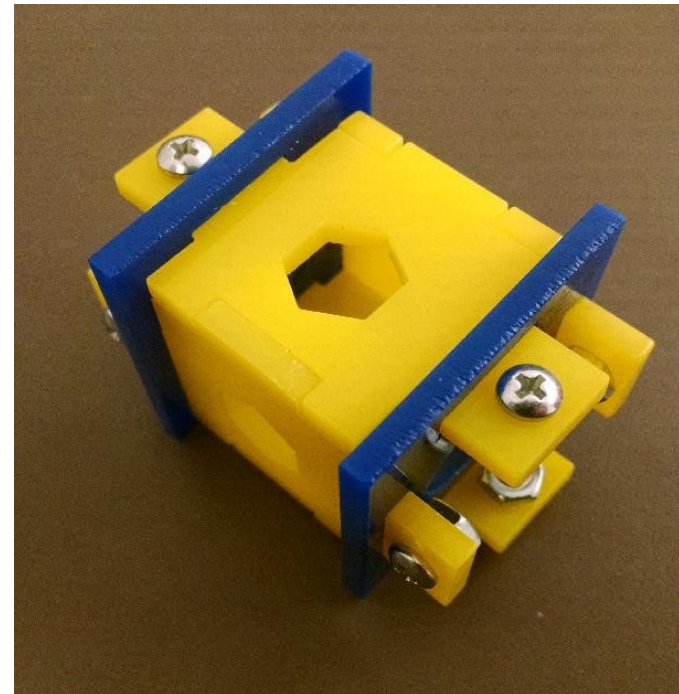
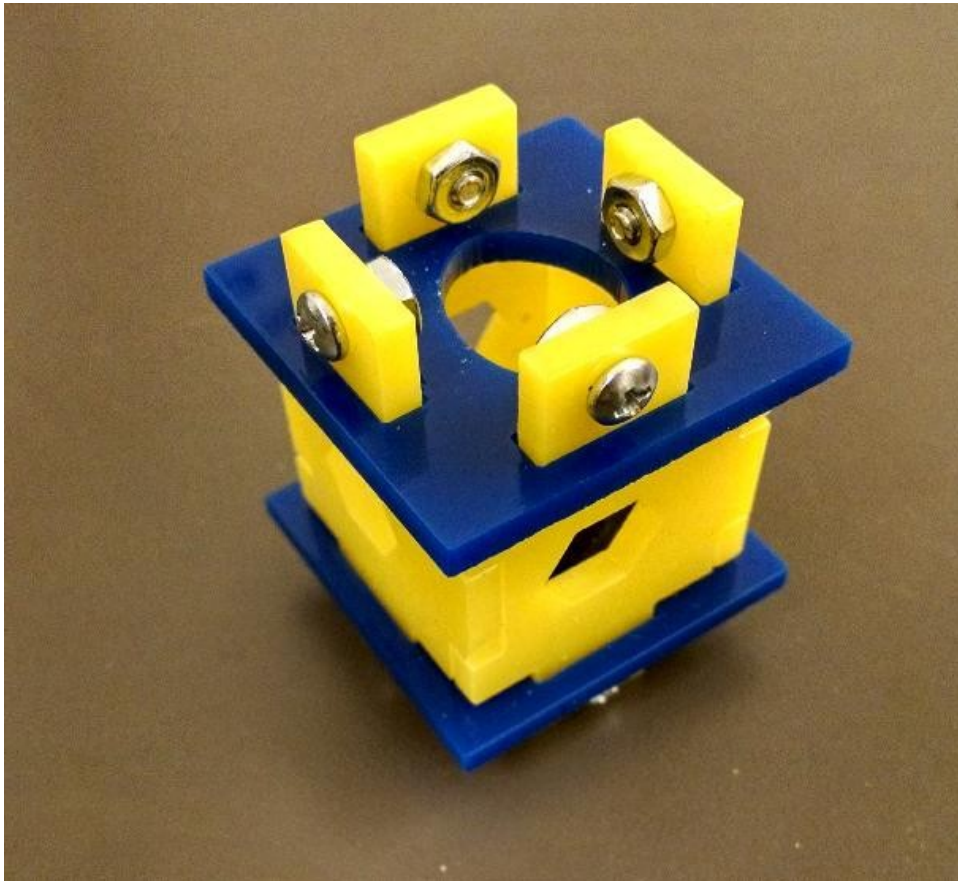

# Making a Flush Box

- Tabs are flush with the slots
- Fastened with acrylic cement

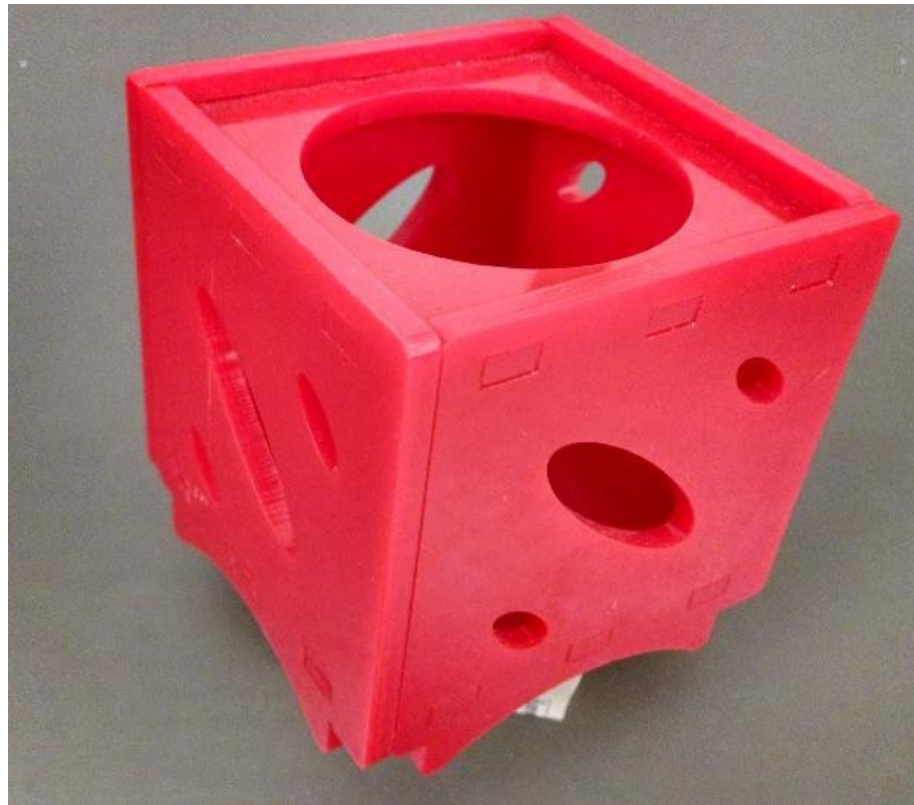

# T-Slot Joints

- Nut embedded in the panel
- Panels held under tension

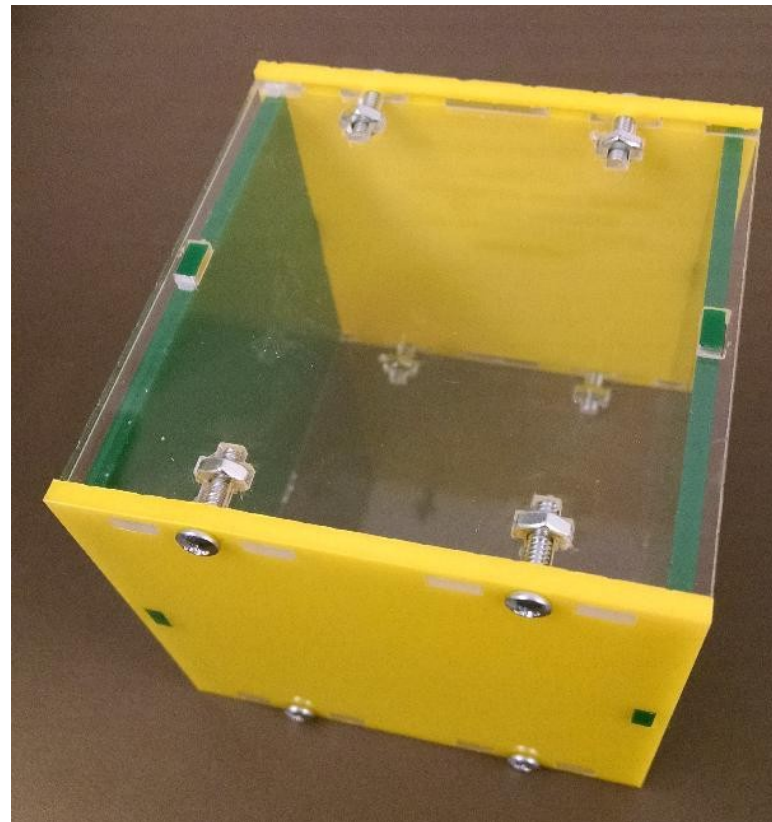

# T-Slot in Wood



Image from Xiaoyang Kao  
xy-kao.com

# Dragon's Claw Joints

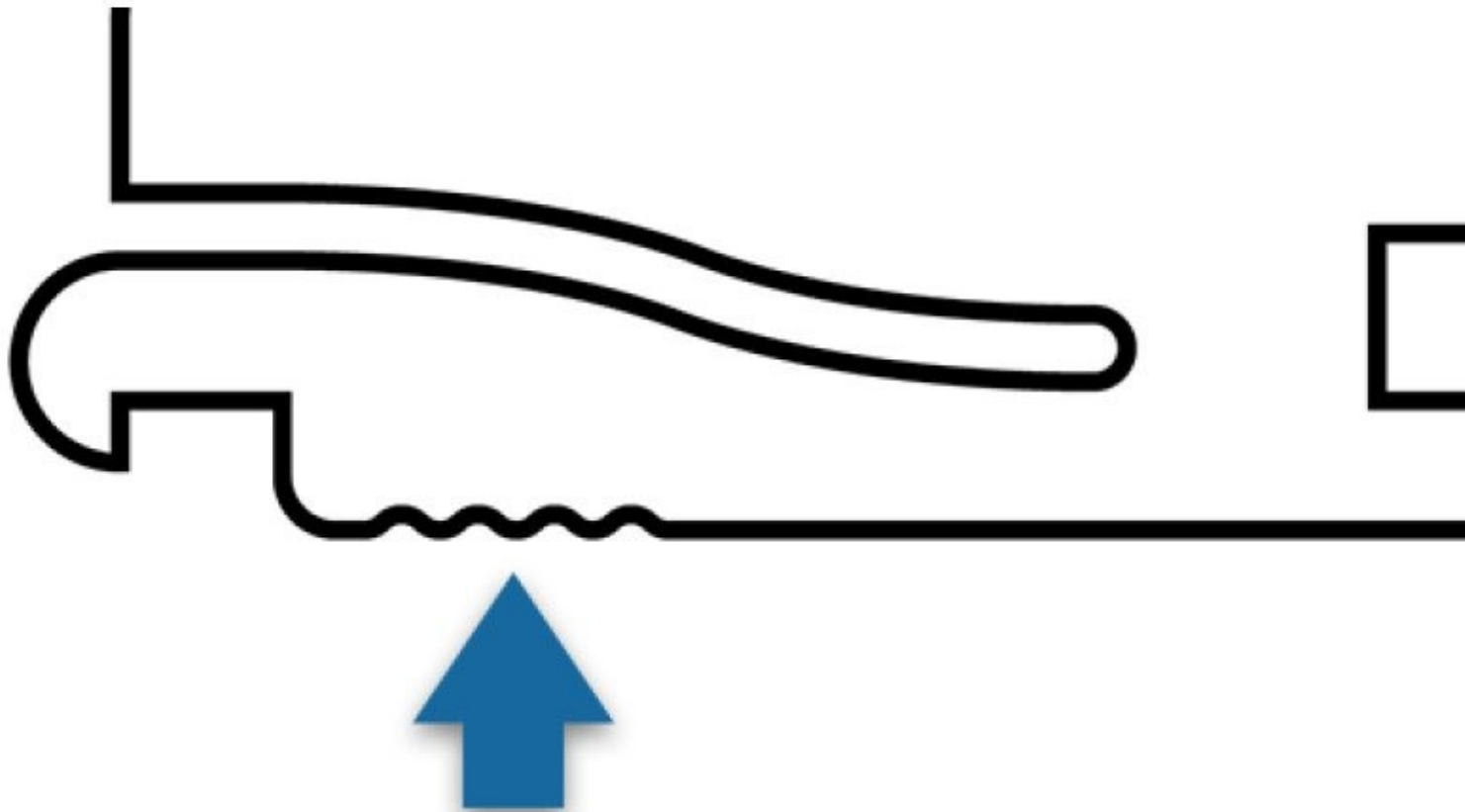

Image from Phil Burgess, Adafruit Industries.

# Dragon's Claw



Image from Phil Burgess, Adafruit Industries.

# Mirror Matching Parts Instead of Copying Them

Compensates for laser cutter asymmetries:  
beveled edges due to depth of cut. Otherwise  
you get a skewed parallelogram instead of a box.

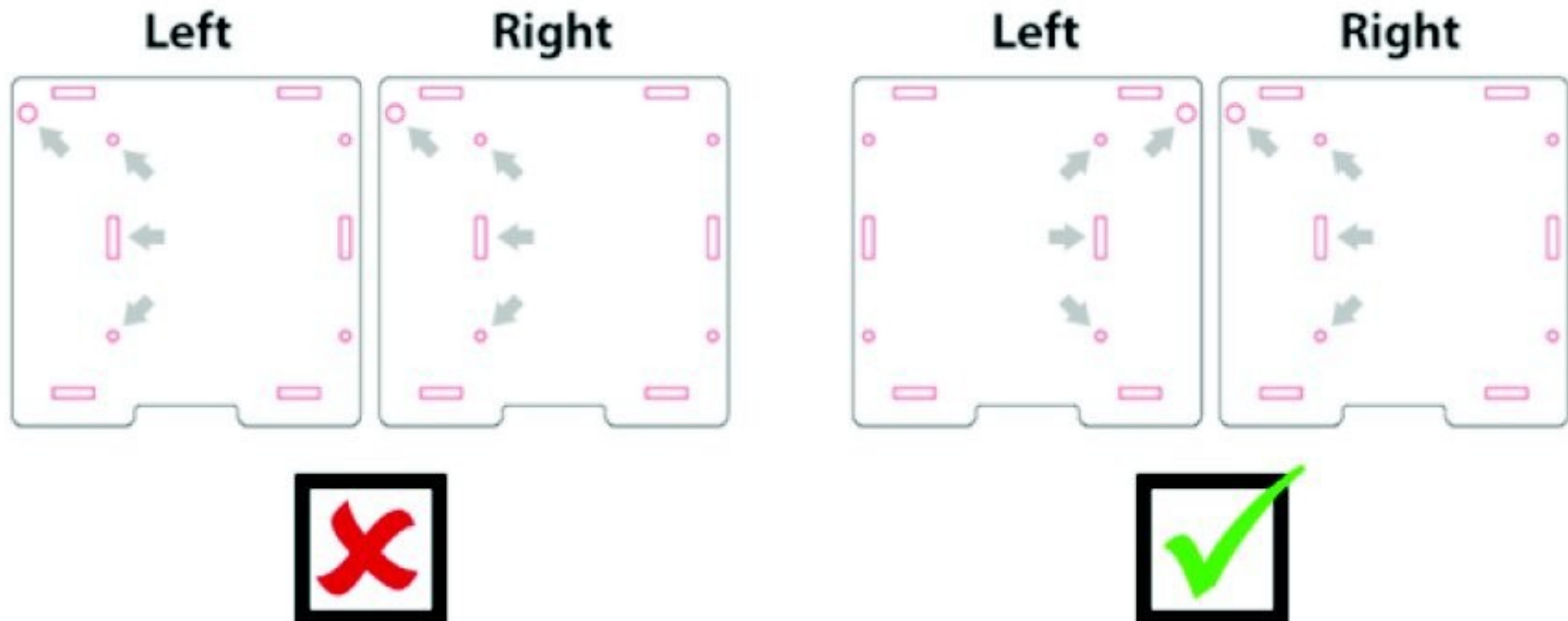



# Mirror to Counteract Skew

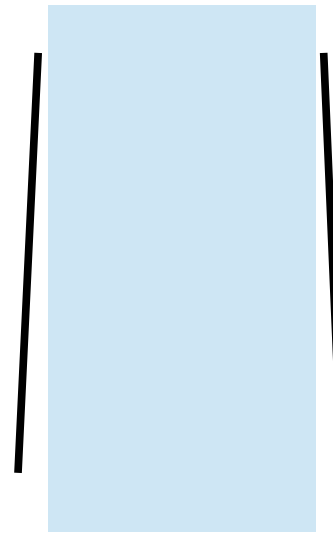
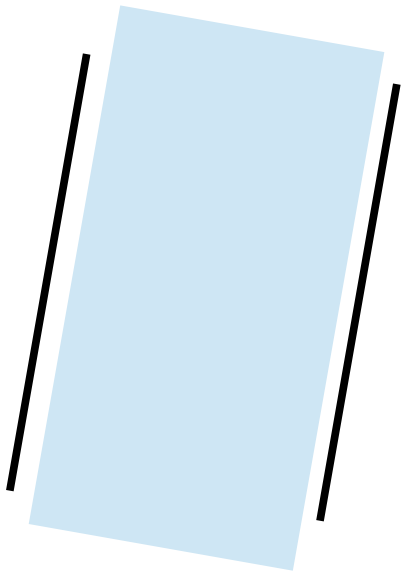

# “Living Hinge” in Wood

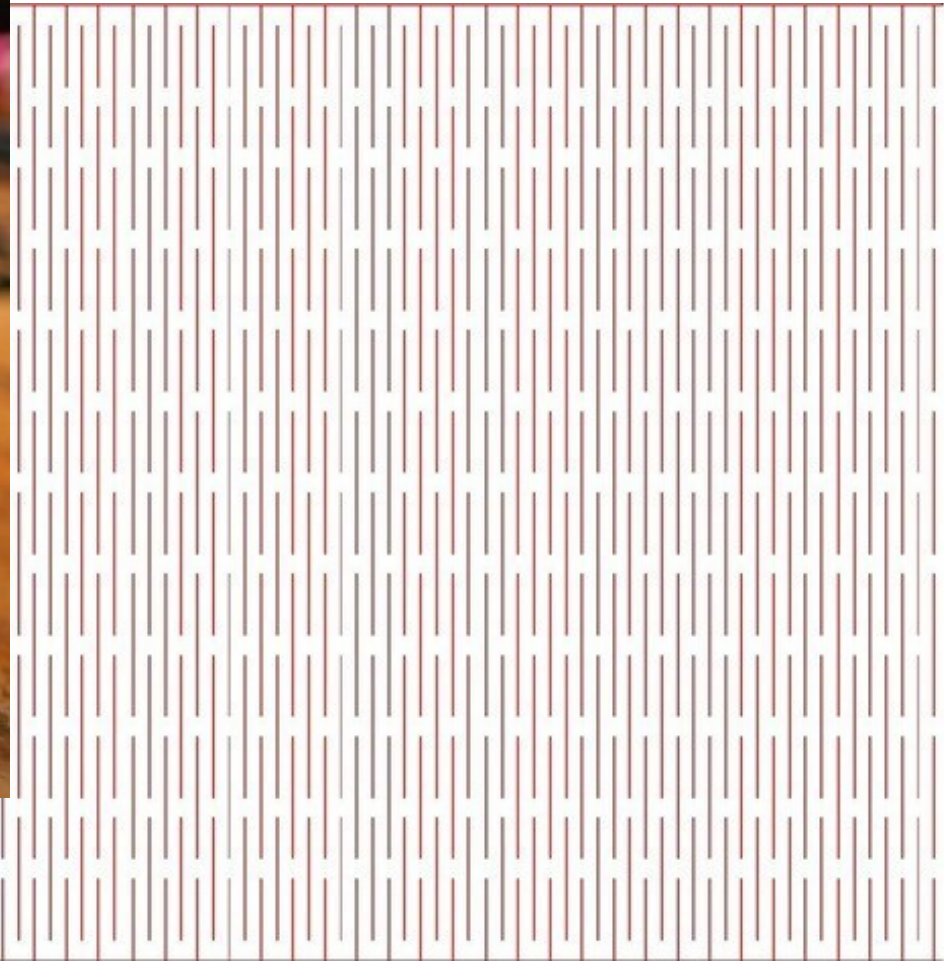

# Living Hinges

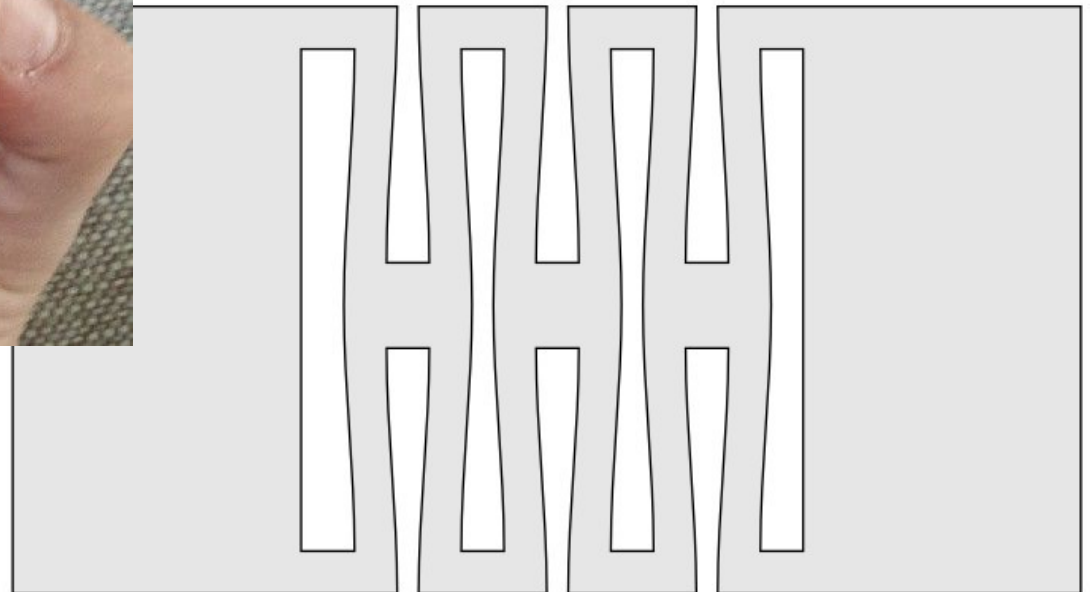
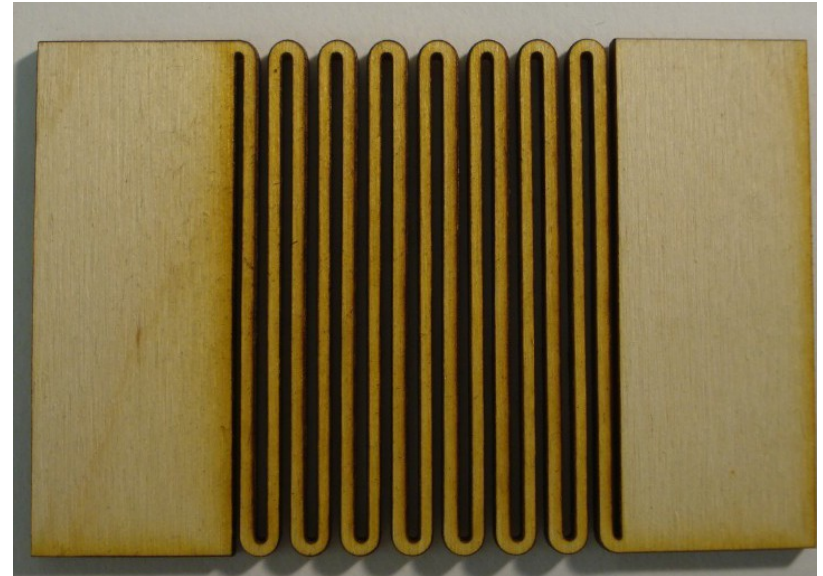

# Engraving

- Engraving uses raster scan to fill in an enclosed contour.
- Select “Engrave” instead of “Cut” in the laser client program.
- To engrave acrylic, use these settings:  
speed 325 mm/sec, power 15%.
- Higher power will cut deeper but can leave artifacts.

# Engraving Acrylic

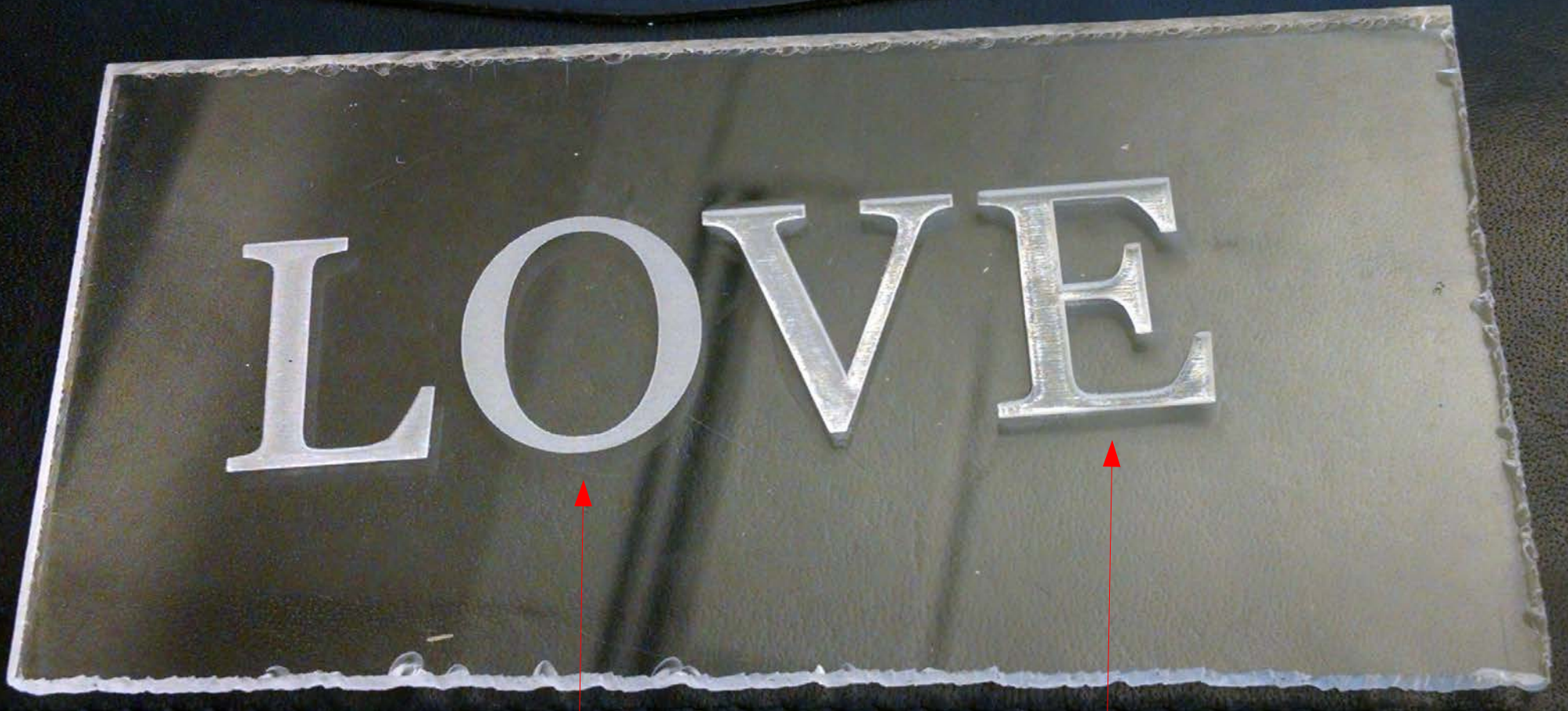

**15%  
power**

**60%  
power**