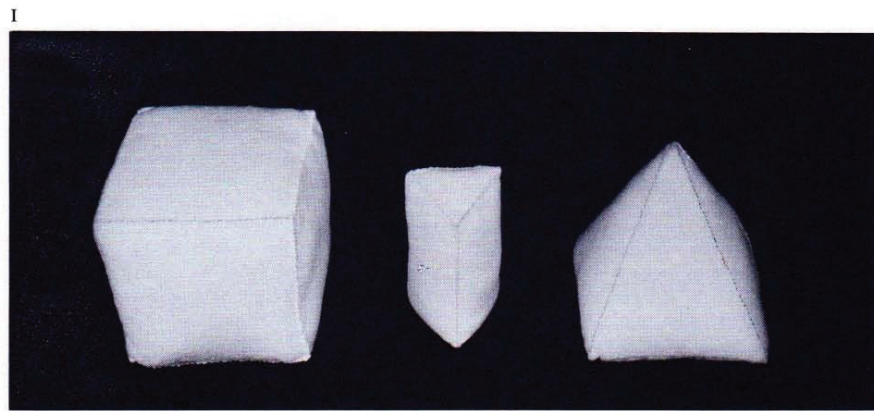
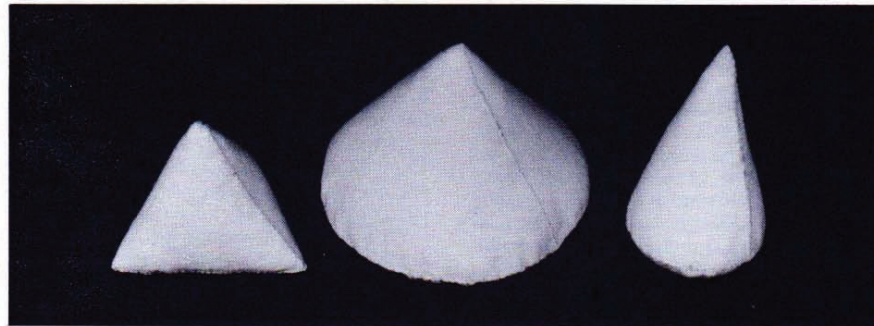

Plate 10 GEOMETRIC FORMS

A B C D E F G H



A B C



D E F



G H I

Pattern 3 GEOMETRIC PATTERNS

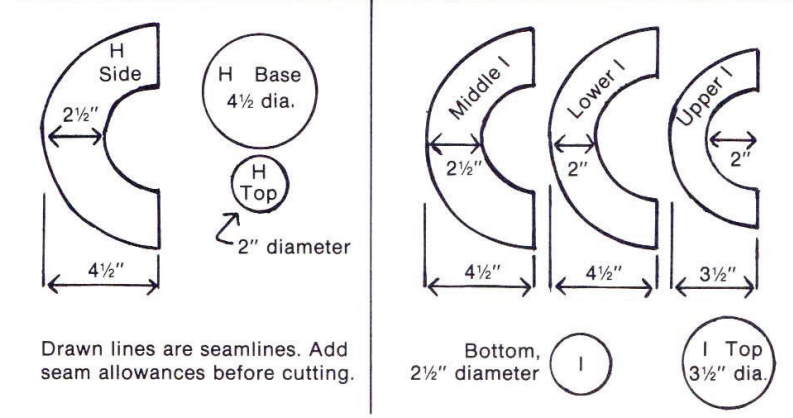
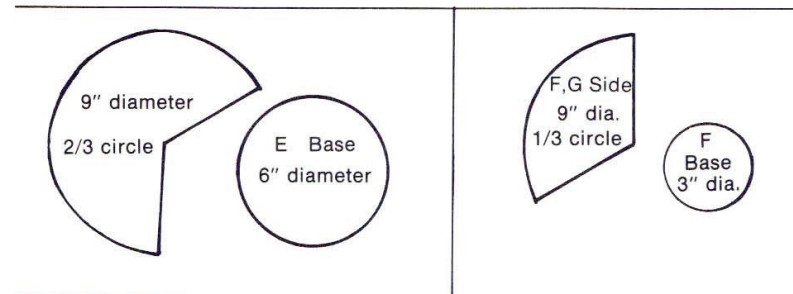
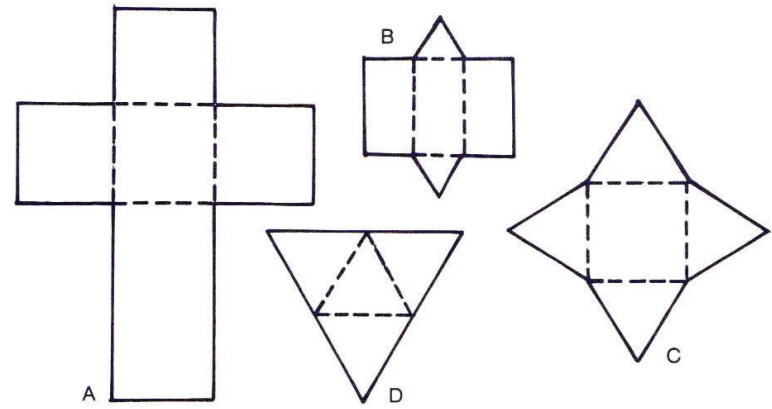

Drawn lines are seamlines. Add seam allowances before cutting.

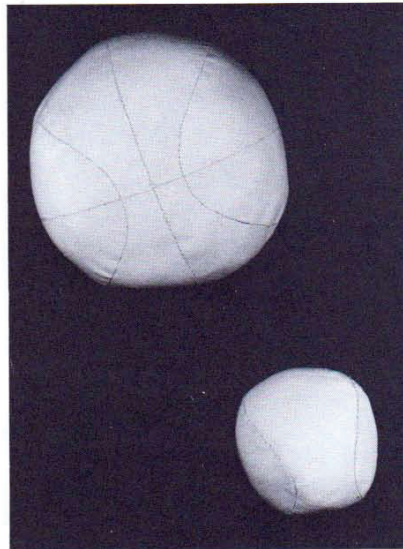

A. Basketball B. Softball



C. Football D. Football segment



E. Sphere F. Sphere segment G. Truncated sphere

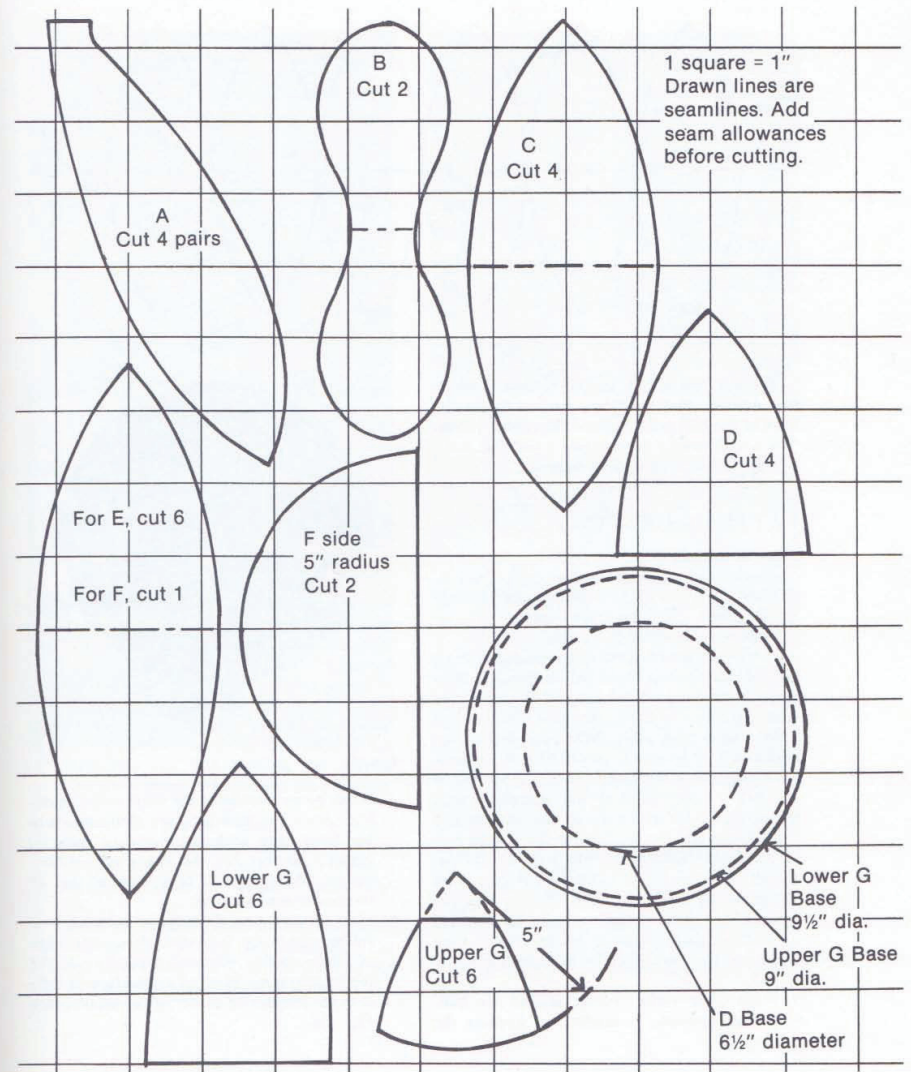

Cone

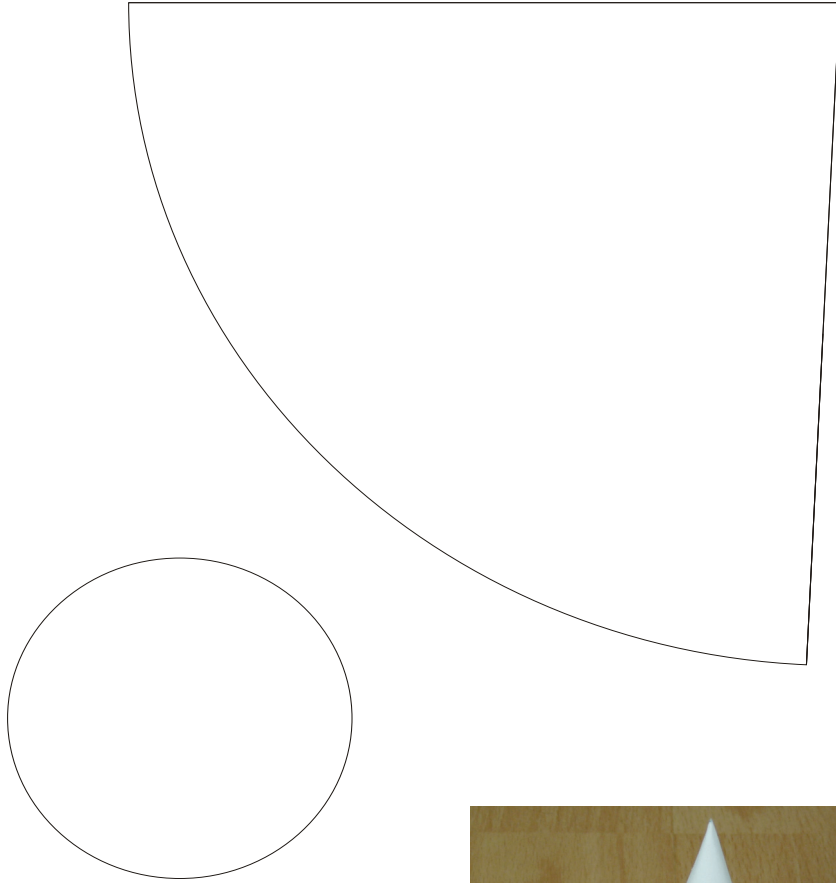

Cube

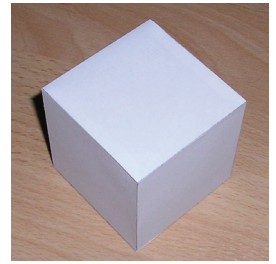
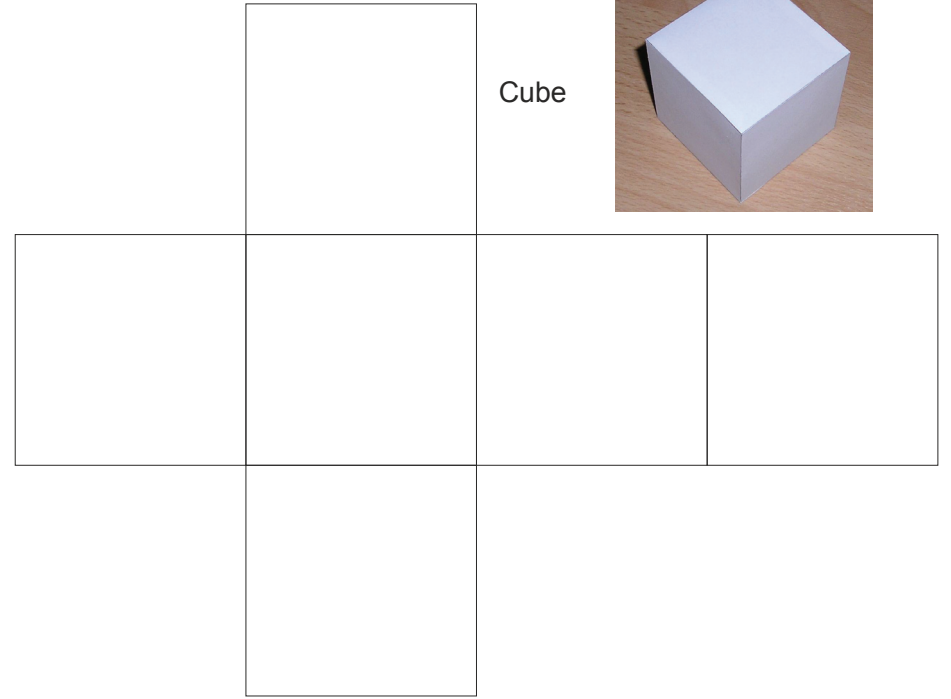

Tetrahedron

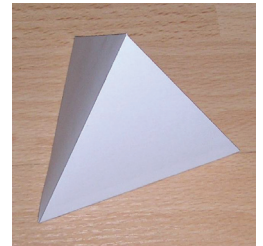
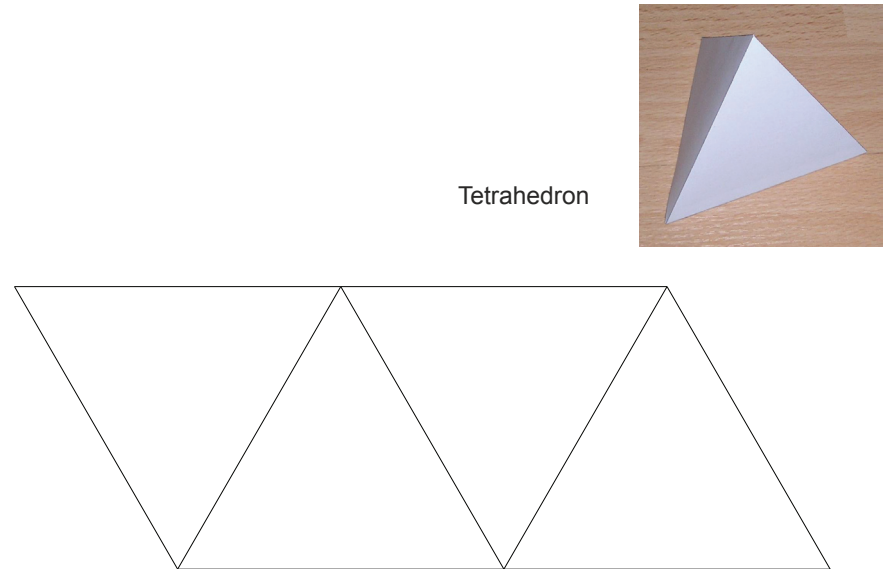

Cylinder

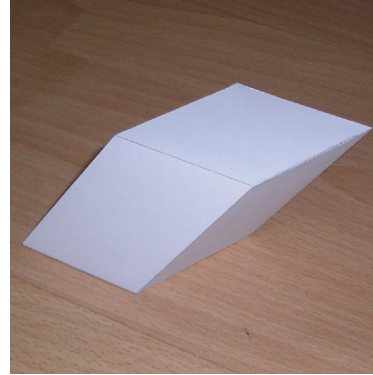

Oblique Rhombic Prism

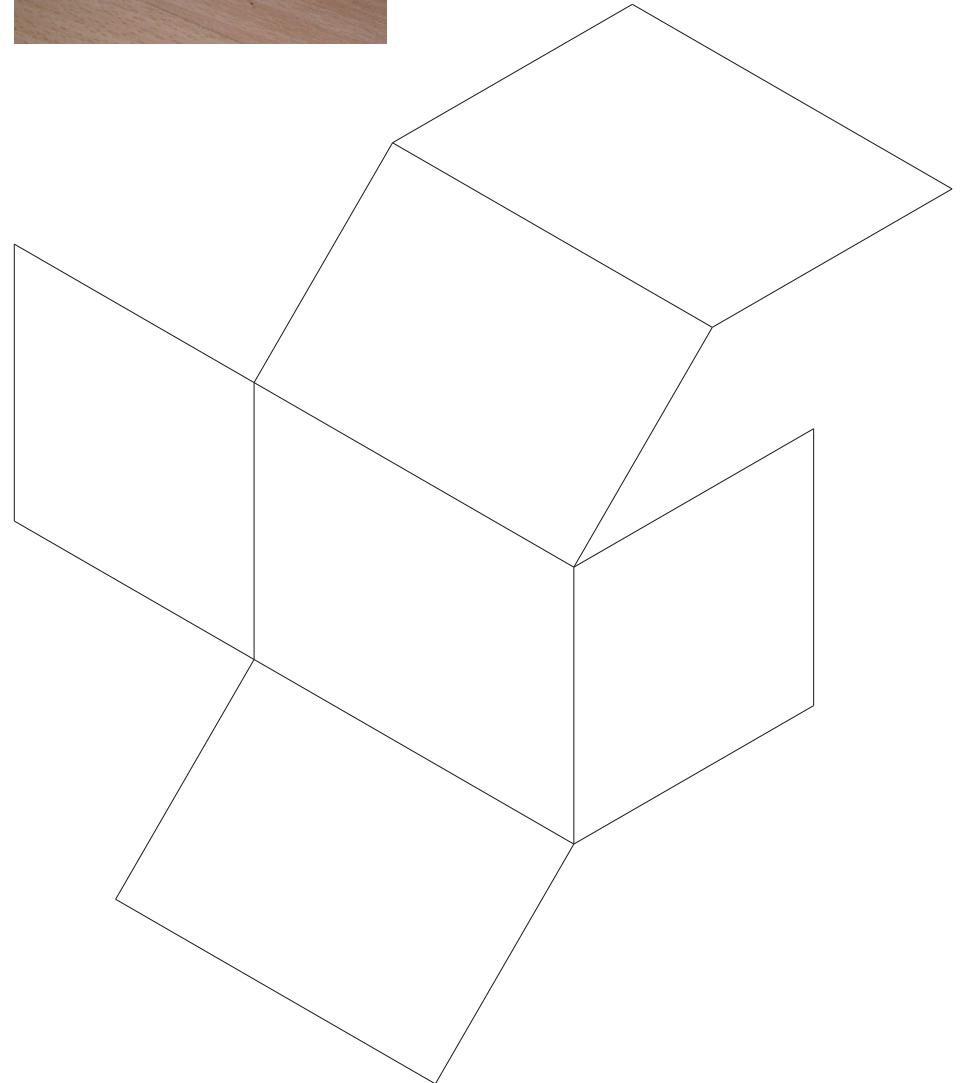
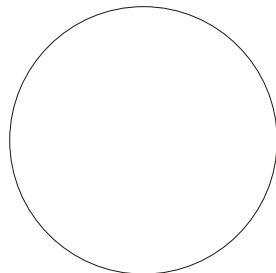
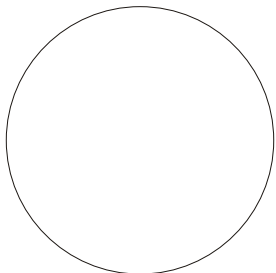
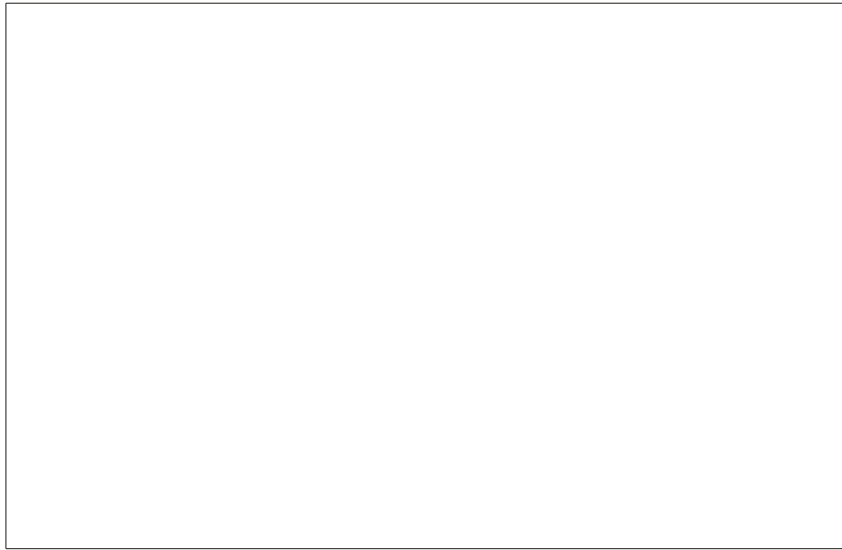

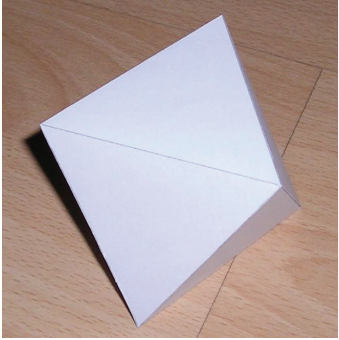

Octahedron

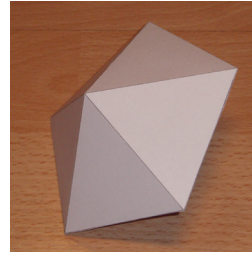
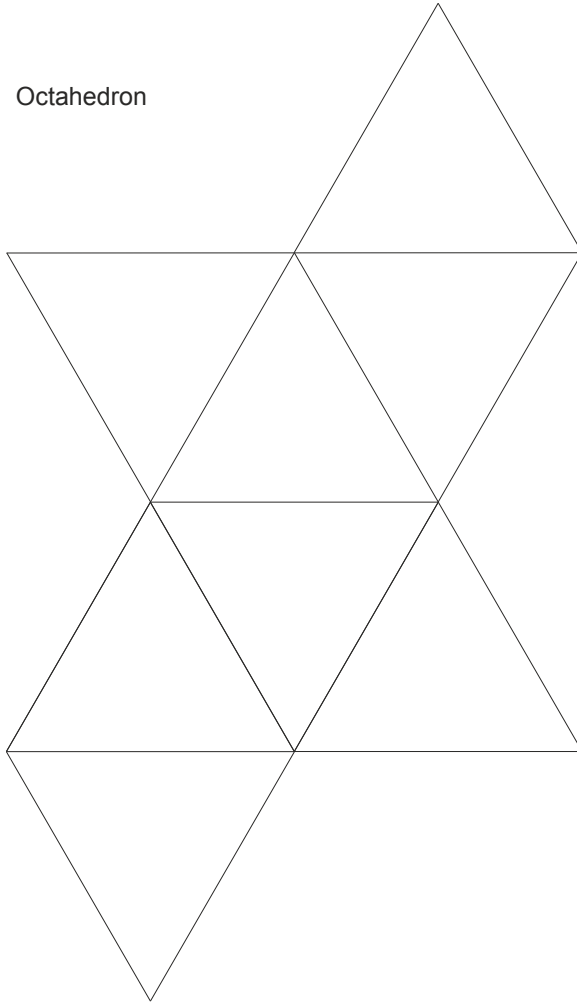

Pentagonal Dipyramid

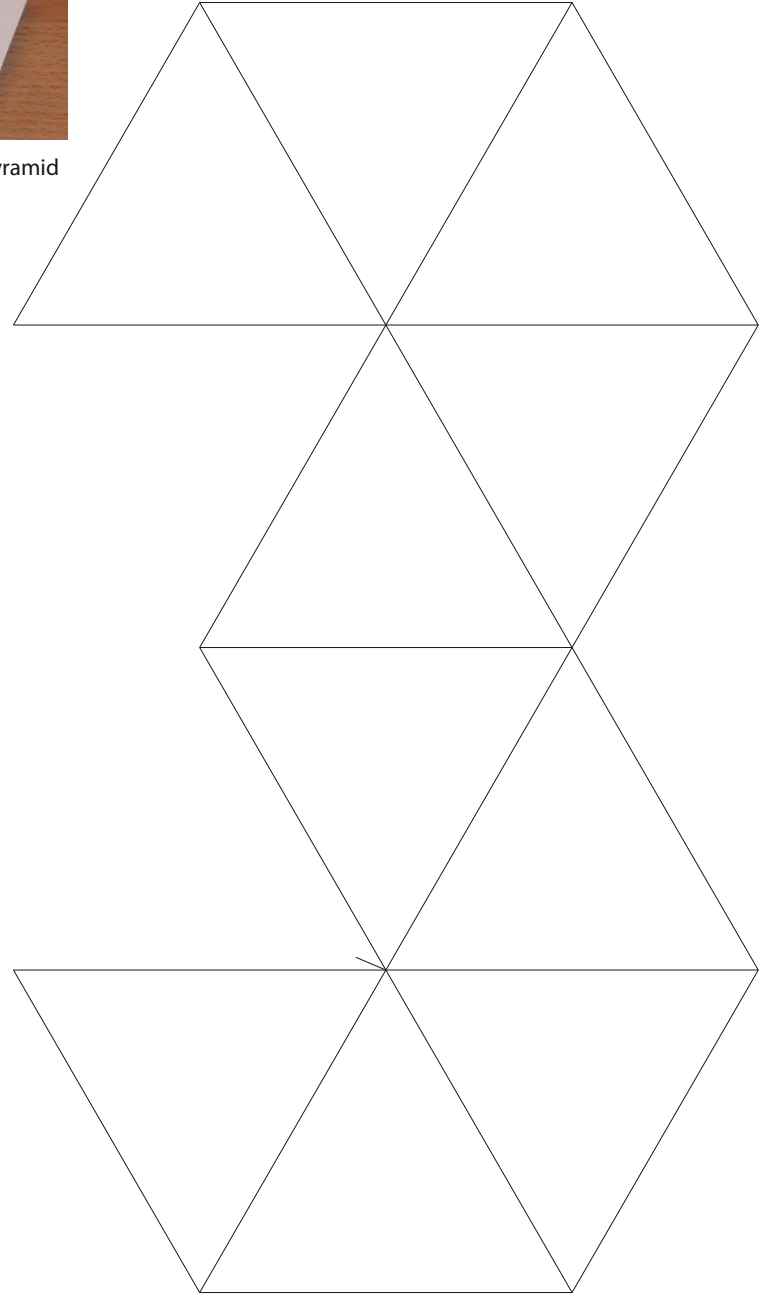

# Hexagonal Pyramid

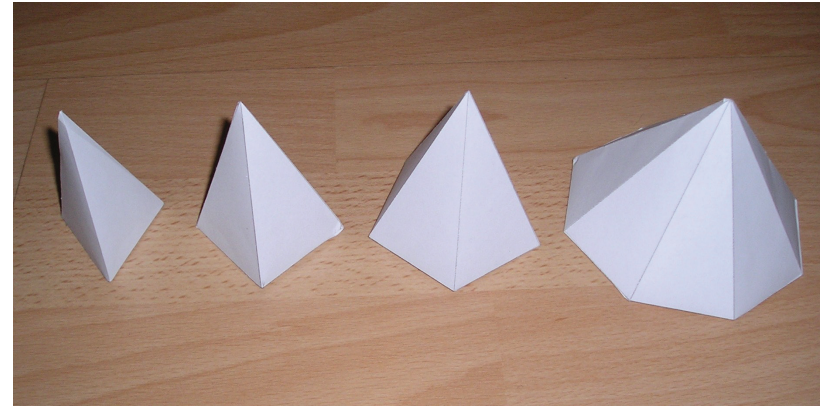
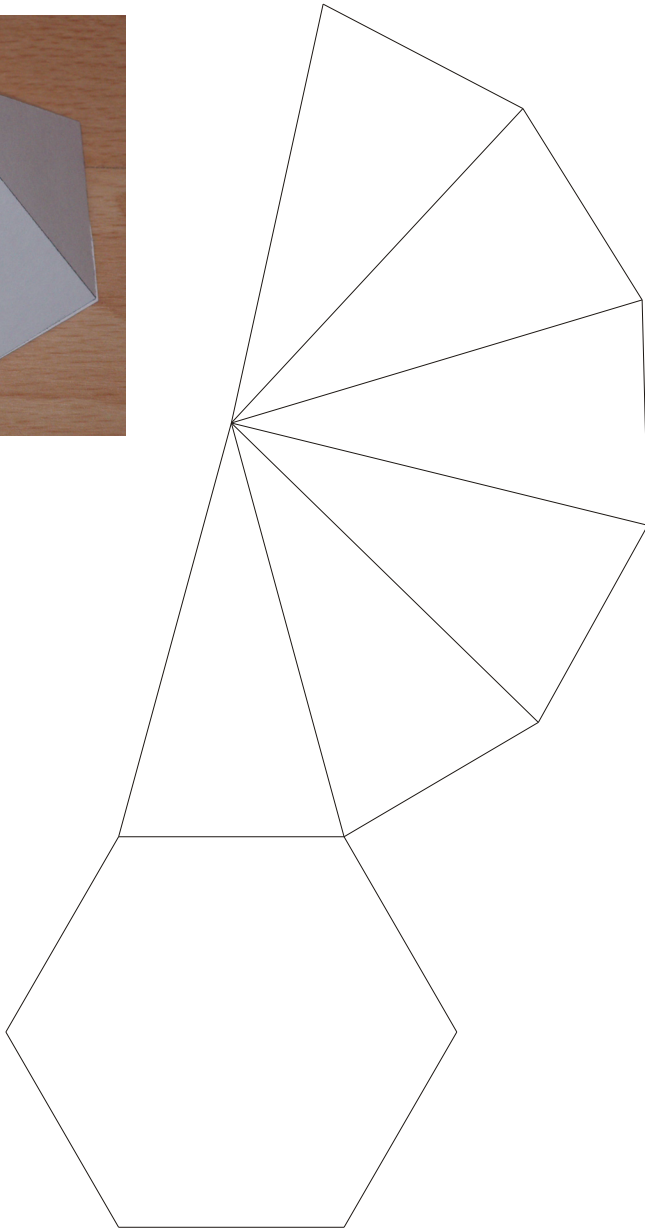
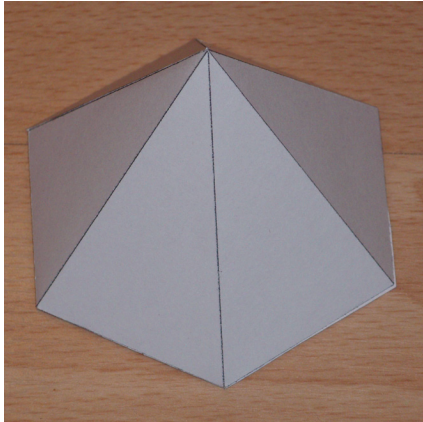

triangular pyramid   square pyramid   pentagonal pyramid   hexagonal pyramid

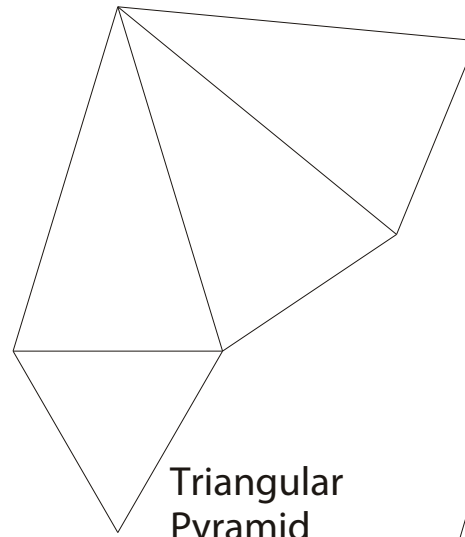

Triangular  
Pyramid

image of a shorter  
square pyramid

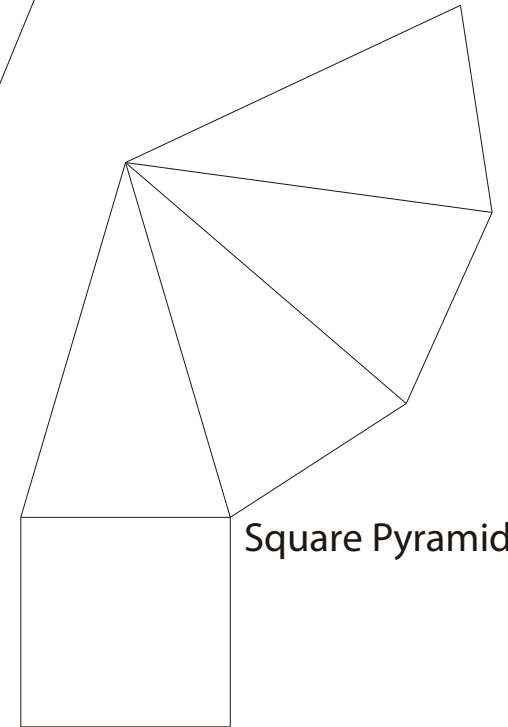
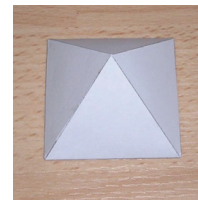

Square Pyramid